

# The accurate measurements of biologically effective ultraviolet radiation<sup>1</sup>

Marian Morys and Daniel Berger  
 Solar Light Co., Inc.  
 Philadelphia, Pennsylvania 19126, USA  
 Phone: 215-927-4206, FAX: 215-927-6347

A UV-B meter having sharply increasing sensitivity with decreasing wavelength can be shown to well represent a large number of known biological action spectra. The accuracy of the meter, which is temperature stabilized, and its long term stability enable accurate UV and UV trend information to be obtained. The meter is readily calibrated in the laboratory or in the field since it has cosine law agreement. Spectral responses between meters are negligibly different. The meter requires very little maintenance. An on-board computer stores months of data and can be remotely interrogated. The initial cost is low making an extensive network possible. The redundancy of a network enables long term UV trend determinations to be made with even greater confidence than that from a single meter.

## 1. INTRODUCTION

Stratospheric ozone is known to be the most important atmospheric factor determining clear sky UV-B radiation reaching the Earth's surface. The potential increase of UV-B exposure is the cause of mounting concern about the ozone layer. There are, however, other effects that influence the UV radiant energy transfer: cloud cover, aerosols, tropospheric ozone, and other gaseous pollutants<sup>1</sup>. The relationships between various phenomena taking place in the atmosphere are complex and not well known. Therefore, ground based UV measurements are necessary to explore atmospheric changes and resultant effects on the biosphere.

## 2. BIOLOGIC EFFECTS OF UV RADIATION

The fact that ultraviolet radiation affects living organisms was already known in the 19th century. The technological and scientific advances at the beginning of 20th century made it possible to measure and understand some of the biologic effects of UV. In their paper published in 1921, Hausser and Vahle described the experiment that allowed for the measurement of the wavelength dependency of erythema<sup>2</sup>. The modern classification of UV radiation into 3 bands: UV-C, UV-B and UV-A was accepted at the Congress of the Comité Internationale de Lumière in 1932. It was first proposed by

Saidman and was based on the differences of the biologic effectiveness in those bands. Since then many studies have been performed to determine the action spectra for biological objects other than human skin.

It is the intention of this paper to ascertain the usefulness of different types of UV meters to monitor the biological effectiveness of the solar radiation, in relation to biological action spectrum. The following action spectra are taken into account: Erythema Action Spectrum<sup>3</sup>, DNA to Protein Cross links<sup>4</sup>, DNA Breaks<sup>5</sup>, Polychromatic Action Spectrum for Higher Plants<sup>6</sup>, Phytoplankton Photoinhibition<sup>7</sup> and Typhimurium Killing<sup>8</sup> (Fig 1.).

The criteria to select the above spectra was their diversity and their coverage of a spectral range. Only the portion of the action spectrum above 290nm has any meaning for solar radiation measurements and only this wavelength range was taken into consideration. Although different, the selected action spectra have some common characteristics. All increase sharply

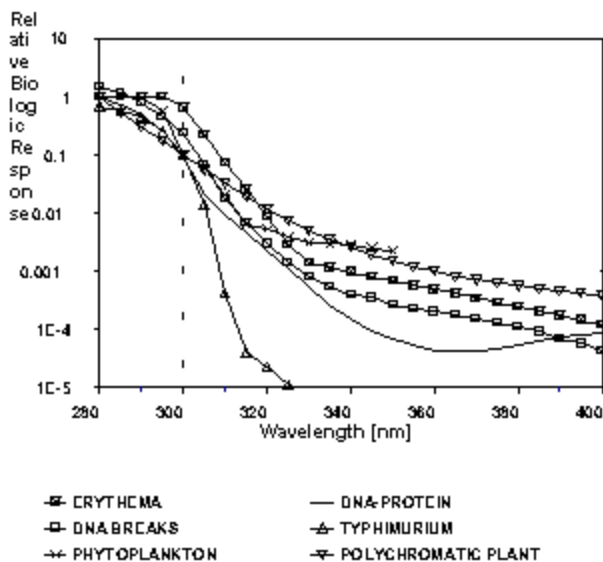

Fig. 1. Selected biologic action spectra.

<sup>1</sup>Paper was presented at the *International Symposium on High Latitude Optics*, Tromsø, Norway, July 1993

towards shorter wavelengths in the region of 290-340 nm. For many there is a characteristic UVA plateau. It is often difficult to establish a unique action spectrum for a photobiologic process because there may be interactions between effects at different wavelengths, repair processes may be significant during irradiation, the end point may be delayed or not well defined. The overall uncertainty of the published action spectra varies from as little as  $\pm 17\%$ <sup>3</sup> to approximately 100%.

### 3. UV MEASUREMENT TECHNIQUES

There are 3 functions for a UVB meter. 1) To monitor light sources for their stability and for their UVB effectiveness, 2) to establish whether a biologic effect is the result of either UV-B intensity or dose and 3) to monitor sunlight for long term UV-B trends.

#### 3.1. Measurement requirements

Since most of the biologic effects are sensitive to the accumulated dose (as opposed to the threshold) the instrument must provide continuous measurement or sampling rate fast enough in relation to the rate of irradiance changes.

The stability is a major factor. Many observed or expected biologic effects of UV may require measurement over ten or more years. To determine whether there is significant correlation between the effect and UV exposure, the measurement has to be free from drifts both long and short term. To perform comparative studies the repeatability from unit to unit has to be assured both in terms of spectral as well as cosine response and calibration precision. The absolute accuracy of the calibration is not a critical issue since in most cases there is no precise link between the absolute UV exposure and biologic effect. Precision, however, is of great importance.

Severe conditions under which the biological effectiveness measurements may be performed impose a requirement for high reliability and durability. In most field applications the meter has to operate autonomously or with little human intervention. It implies simplicity of operation and automatic data collection. Portability could also be an important asset.

#### 3.2. Scanning instruments

There are few commercially available scanning spectroradiometers that can be used for long term outdoor operation but new ones are being developed. Their purpose is to measure the spectral distribution of incident light. To determine the biologic effectiveness of measured radiation the spectral irradiance vector has to be multiplied by the transposition of the action spectrum vector which is defined over the same wavelength range.

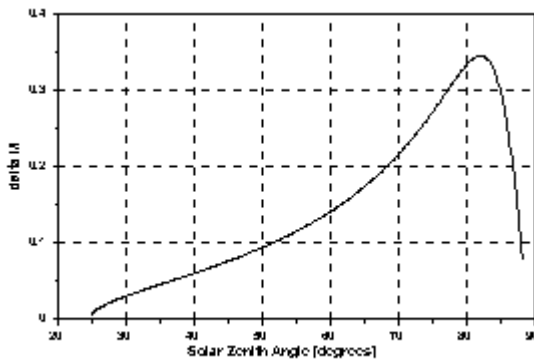

Fig. 2. Change of the erythemally weighted solar radiation in 10 minute intervals related to its value in the middle of the interval (45°lat., 20° solar declination, 3mm O<sub>3</sub>, 0 albedo,)

The main advantage of the spectroradiometer is that the biologic effectiveness for any action spectrum can be calculated. Additionally, the details of the spectrum bear information about the composition of the atmosphere that is needed by physicists and climatologists. There is presently no alternative instrument suitable for this kind of research. However, if used for monitoring biological effectiveness of solar radiation, the currently available spectroradiometers do not deliver error free results: the long scan time, the scan frequency, and the limited lifetime of the mechanical components introduce errors when measuring varying irradiance. Fig. 2 shows, that during a clear day and under the conditions specified for this example the erythemally weighted irradiance can change by as much as 35% in a 10 minute interval. Additional variability of irradiance is caused by changing cloud cover and in most cases the spectroradiometric measurements are performed only during clear sky conditions. This seriously limits the accuracy of the dose integration by a spectroradiometer and raises a question whether the biological monitoring of daylight cannot be achieved by cheaper and simpler means.

High diversity of local conditions makes it necessary to provide dense coverage with measurement sites. That is when other factors, such as high cost, complexity, the need for constant re-calibration and highly qualified service personnel become important and will often exclude spectroradiometers from broad usage in photobiologic applications.

### **3.3. Broad band and spectral line instruments**

There are basically two categories of instruments under this classification. The phosphor-based Robertson-Berger (RB) meter and interference filter based instruments. Both have fast response and are relatively inexpensive. They can measure one band shaped to a selected action spectrum or a series of narrow (in an order of 5nm) bands, are small in size, rugged and can operate virtually without human intervention.

While very useful for some applications, interference filters were not used in long term monitoring of UV because of their lack of long term stability, especially when exposed to UV. Many efforts have been put into improving their performance but so far no report has been published showing that those efforts have been successful.

The concept of a phosphor-based UV-B instrument came from Dr. Robertson<sup>9</sup>. Improved in cooperation with Berger<sup>10</sup> it served as a basis for the NOAA network established in the early 70s. Despite its temperature dependency<sup>11</sup> it delivered stable and reliable data over long periods of time<sup>12</sup>. The stability of its spectral response was exceptional. As shown by DeLuisi<sup>13</sup> the spectral response measured in 1992 was not different from that measured in the 70s. The meter was also stable in terms of calibration over very long periods of time. The stability of the meter was probably superior to the accuracy and precision of the calibration technique available.

The spectral response of the RB meter was designed to follow the Erythema Action Spectrum. As will be shown in the following paragraphs there are other action spectra that will respond the same way to solar radiation as does erythema.

## **4. UV-BIOMETER**

Growing interest in the UV-B measurements, proven reliability of the phosphor technology, positive results of the tests of the temperature stabilized RB sensor<sup>14</sup> and advances in technology encouraged us to develop an improved version of the RB meter. The UV-Biometer inherited the best from the original design and benefited from the technology available today to eliminate the temperature dependency, improve spectral and cosine responses and offer the functionality expected from today's instruments.

### **4.1. Construction of the instrument**

Model 501 UV-Biometer consists of the detector (Fig. 3) designed for outdoor operation, and the recorder that performs all control and data storage functions. The signal from the UV sensor is amplified and converted to frequency inside the detector and then transmitted to the recorder. This assures high noise immunity even with very long cables. High grade components are used to minimize temperature effects on the electronic circuitry. The metal detector case is hermetically sealed and pressurized with dry neutral gas for additional protection of the sensor and circuitry. The desiccator plug removes any residual moisture and serves as a humidity indicator.

The recorder is operated by a micro-controller with additional interfacing and buffering circuitry. The Liquid Crystal Display and a keypad along with a tree-structured menu provide a convenient way to set up the instrument. All functions of the instrument are defined by the software and can be modified according to specific user needs.

### **4.2. Spectral response**

The sensor of the detector is a combination of absorption filters, phosphor and a GaAsP diode that together give a spectral response close to that of the Erythema Action Spectrum (Fig. 4.). The improvement of the spectral response in comparison with the original Robertson-Berger meter was achieved by a change in the phosphor application. The detector's response for wavelengths shorter than 290 nm is not important when solar radiation is measured, even if the ozone column thickness was reduced to 1mm.

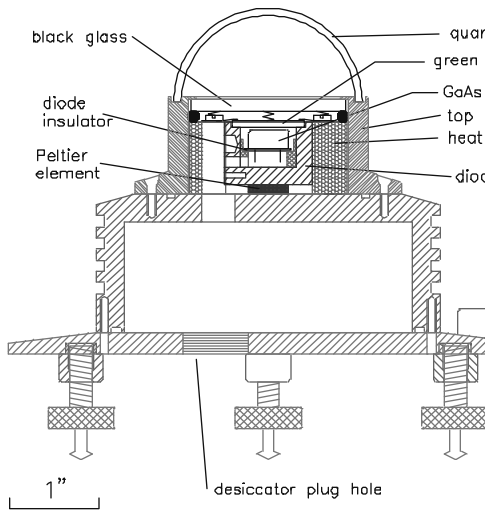
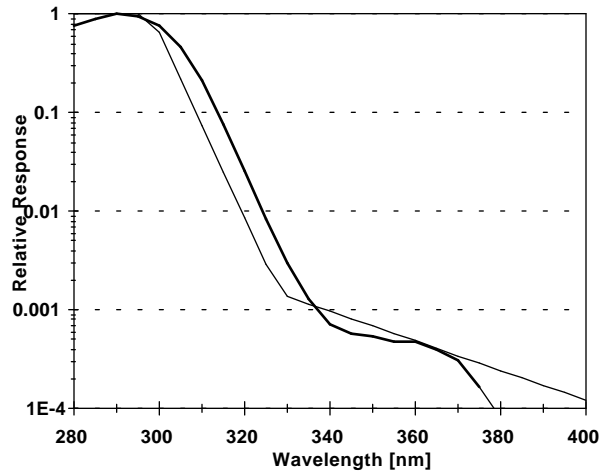
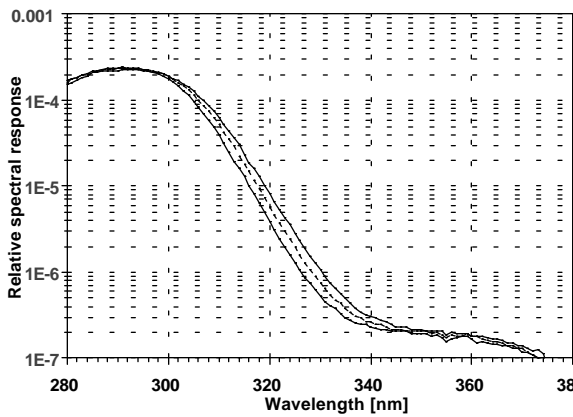

Fig. 3. UV-Biometer Detector.



— UV-Biometer      - - - Erythema Action Spectrum

Fig. 4. Spectral response of the UV-Biometer.



— @5 degC · - - @25degC · · · @45degC

Fig. 5. Temperature changes of the spectral response in phosphor based UV sensor.

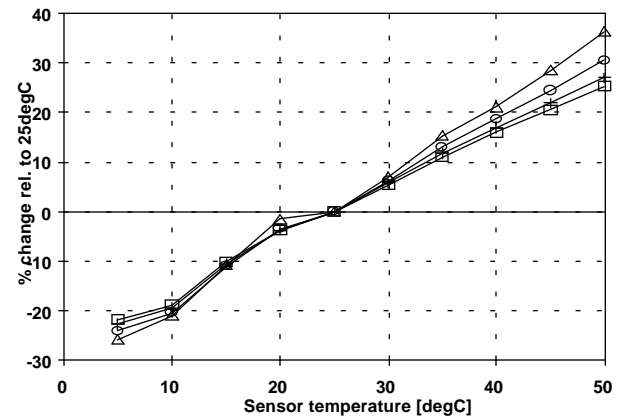

■ 0deg, 3mm □ 30deg, 3mm ○ 50deg, 3mm △ 70deg, 3mm

Fig. 6. Temperature coefficient of the UV-Biometer under solar radiation.

One of the effects debasing data accuracy of the Robertson-Berger meter was the temperature dependence of the sensor. It was previously estimated to be approximately 0.8%/°C under average solar zenith angle and ozone conditions. The temperature coefficient of the UV-Biometer detector as well as its components were determined to find an effective way to eliminate the temperature error.

The temperature coefficient of the black filter (UG11) was measured and found to be below the measurement error of 0.1%/°C from 300 to 370 nm, and was 0.2%/°C between 285 and 300 nm. Above and below those wavelengths the temperature coefficient of the black filter is substantially higher but does not affect the measurement of solar radiation since it is apart from the effective band of the meter. It was concluded that the stabilization of the black filter is not essential. It made the whole task of stabilizing the

The GaAsP diode is not biased and its temperature coefficient at 500nm (the peak of the phosphor emission) is zero within 0.05%/°C accuracy. Nonetheless, the diode is thermally stabilized to assure its long term stability and extend its lifetime.

The phosphor applied to the surface of green filter was found to be the primary contributor to the resulting temperature coefficient. The sensor (diode, green filter and phosphor) was positioned at the exit of the spectroradiometer with a calibrated output. A stable 150 W xenon arc lamp at the input of the spectroradiometer was the light source for the experiment. The temperature of the detector was stabilized at temperatures from 5 to 50°C in 5°C increments. The spectral response of the sensor was scanned for each temperature and then convoluted with the transmission of the black filter to obtain the spectral response of the complete detector. The bandwidth of the spectroradiometer was set to 2.5nm. It was narrow enough to accurately measure the steep edges of the spectral response and still provide a sufficiently strong signal.

Figure 5 shows the measured spectral response at three different temperatures. The phosphor/green filter assembly exhibits significant positive temperature coefficient in a wavelength range of 300-345nm. The temperature coefficient is wavelength dependent and therefore changes of the detector temperature coefficient can be expected with the changing spectrum of the solar radiation.

The meter's spectral response at different temperatures was used in a computer simulation with Green's Solar UV Radiation model<sup>15</sup> to determine the temperature coefficient of the whole detector under various ozone and solar zenith conditions. Figure 6 shows the temperature coefficients of the detector calculated for sea level and zero albedo. The overall temperature coefficient varies from 9.1 to about 14%/10°C depending on conditions. Generally, the simulation shows significant dependence on solar zenith angle and some influence of ozone column. The simulation results were confirmed by the measurements of UV-Biometer temperature coefficient under solar radiation.

Two methods are available for eliminating or reducing the effect of temperature on the UV-Biometer. These methods are temperature stabilization and temperature compensation. Either feature can be activated or deactivated independently from the keypad or remote computer. Temperature stabilization eliminates the temperature effects by maintaining a constant detector temperature over an approximately 80°C change in ambient temperature. The range is affected somewhat by wind velocity and the extent to which direct radiation and air temperature contribute to thermal energy ingress to the detector. The cooling capacity is about 25°C while the heating capacity is over 60°C, measured against the actual temperature of the detector housing.

The phosphor/green filter assembly together with the photodiode is mounted in a capsule made of a good heat conductor. It is thermally insulated from the detector housing and mounted on a solid state heat pump that maintains constant temperature of the capsule. The dome, air under the dome, black filter and a thin air gap insulate the phosphor layer from the ambient. The black filter absorbs the visible and IR component of the incident radiation. The resulting temperature increase of the black glass can be substantial during sunny days and its insulation from the phosphor is essential for the stability of the meter and reduction of the power needed to stabilize the sensor temperature.

The detector temperature is constantly monitored. If that temperature deviates from its preset value of 25°C temperature compensation is invoked. A correction scheme assuming linear temperature dependence is employed. A temperature coefficient for correction of 0.97%/°C was chosen based on the fact, that most of the daily total is integrated when the sun is high. For example, at a 40° latitude on September 21 and a cloudless day, approximately 70% of the daily SUV dose is accumulated when the sun is less than a 50° zenith angle. There is also a higher chance of overheating the detector, which can happen when the sun is high, rather than of running the detector too cool. For a high sun (zenith angle <50°) and temperature compensation active the residual temperature coefficient will be within ±0.1%/°C for a wide range of ozone conditions. For a lower sun, the residual temperature coefficient will rise up to about ±0.5%/°C.

For a small temperature differential between actual and nominal (less than 10°C) and the temperature compensation operative the resulting error is negligible. The temperature correction is particularly useful in

### **4.3. Cosine response**

Traditionally instruments for solar radiation measurements have an angular response close to that of the cosine law, therefore measuring the energy flux through a horizontal surface. It is very difficult to make an instrument with perfect cosine response and usually only some of the most expensive instruments, like spectroradiometers, have the complicated entrance optics that assures good angular response for incident zenith angles over 65 degrees.

In the case of Solar UV radiation measurements some compromise is justifiable. First, even when the sun is low, most of the UV energy comes from the sky (scattered UV) and therefore the effect of an imperfect angular response is greatly reduced. Secondly, when the daily dose is measured the biggest contribution is integrated for small solar zenith angles. Lastly, for long term UV trend analysis the shape of the angular response is not as critical as its repeatability across the network and stability with time.

The angular response of the detector is within a 5% error due to the cosine response for incident zenith angles less than 60°. Imperfections of the quartz dome, reflections from the surface of the dome and black filter, non-uniformity of the phosphor and shading of the sensor for high incident angles are causes for the error. To maintain repeatability all mechanical components of the detector are precisely machined. The dome is made from a solid piece of optical grade quartz and accurately polished. All detectors are individually checked for angular response.

### **4.4. Calibration**

The effort was made to develop a calibration procedure that will assure long term stability of the instrument. Two approaches were considered: a calibration by comparison with a reference spectroradiometer under the sun, and a spectroradiometric calibration using an artificial UV source. The second method was finally chosen as the one providing greater precision (repeatability).

In both cases the spectroradiometer calibration error and a transfer error affect the calibration. In well controlled laboratory conditions the calibration is additionally loaded with a constant systematic error associated with the imperfection of the angular response of the detector which is repeatable from detector to detector. In the case of comparison with the spectroradiometer under variable outside conditions the calibration is loaded with additional errors associated with the degradation of spectroradiometer accuracy (changing irradiance, temperature changes, contamination, calibration difficulty). Moreover, the effect of the imperfection of angular response is not constant any more and appears as an additional random component of the calibration uncertainty. The currently achieved absolute accuracy of the Spectroradiometric measurement of solar radiation dose is on the edge if not below the requirements of the scientific community to detect trends in the order of 10%/decade<sup>16</sup>. It seems possible to achieve the same if not better ability to detect long term trends using inexpensive broad band instrument with repeatable parameters and calibration. Particularly since the phosphor based RB meter has an invariant spectrum and sensitivity variations due to photodiode drift from high temperature and cycled temperature should be absent in the stabilized detector. High stability of the meter together with precise calibration will make possible detection of long term trends in UV.

## **5. MEASURING BIOLOGICALLY EFFECTIVE UV RADIATION WITH UV-BIOMETER**

### **5.1. Effect of spectral differences**

When a broad band meter with a fixed spectral response is used it is obvious that its readings will not track exactly the biologic effectiveness of every process in the course of the day and under different ozone conditions. Computer simulation and measurement results were used to determine how big this difference is and whether the error is large enough to disqualify the use of UV-Biometer.

Readings of the UV-Biometer were compared to the biologic effectiveness of solar radiation under different Solar Zenith Angle (SZA) and Ozone conditions. The UV radiation model developed by Green

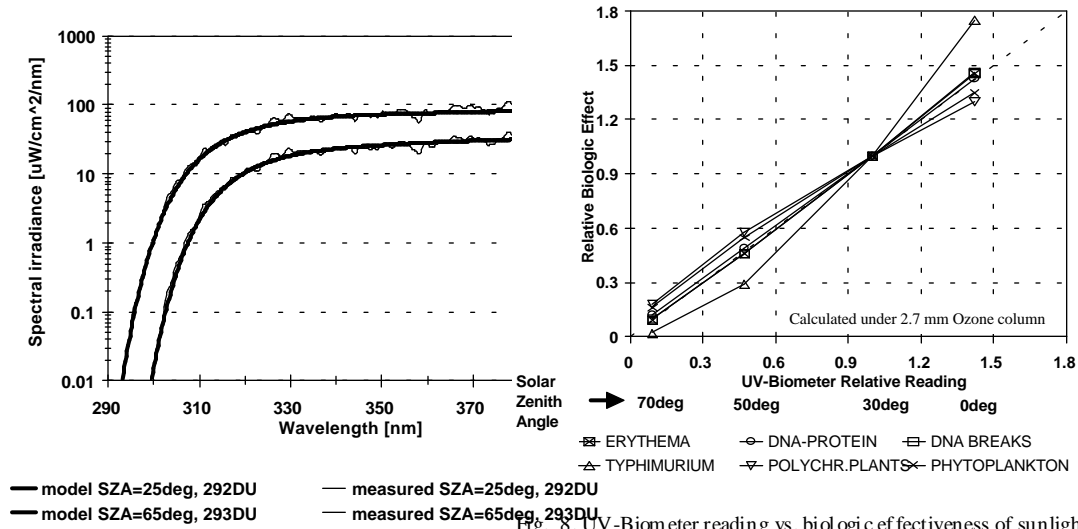

Fig. 8. UV-Biometer reading vs. biologic effectiveness of sunlight under 2.7mm ozone column - computer simulation.

Fig. 7. Comparison of the model with measurements

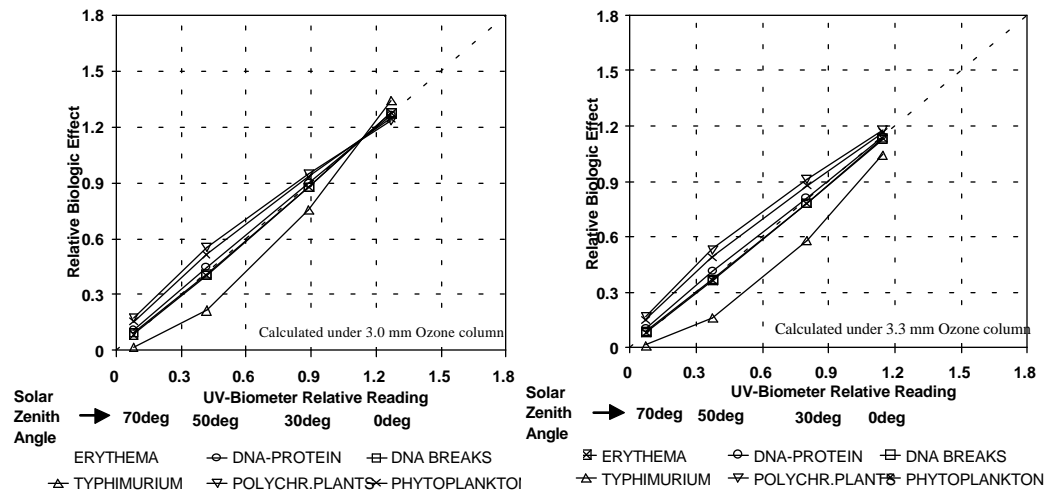

Fig. 9. UV-Biometer reading vs. biologic effectiveness of sunlight under 3.0mm ozone column - computer simulation.

Fig. 10. UV-Biometer reading vs. biologic effectiveness of sunlight under 3.3mm ozone column - computer simulation.

The action spectra presented in Fig. 1 were cross-multiplied by the solar radiation calculated for different solar zenith angles and ozone layer thicknesses. The results were normalized at one arbitrarily selected point and plotted on an XY scale with the UV-Biometer being the X axis. Perfect tracking would show as 45° line across the graph.

The curves on Fig. 8, Fig 9 and Fig 10 show 3 distinctive groups.

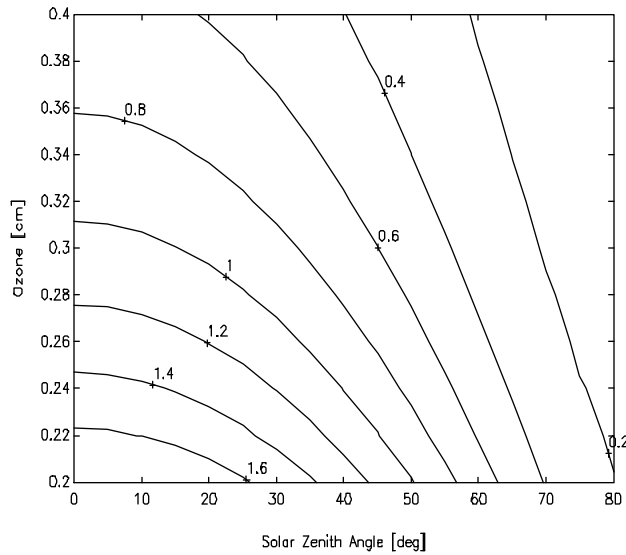

Fig. 11. Correction factors between UV-Biometer and Typhimurium Killing Action Spectrum

Table 1. Radiation Amplification Factor (RAF) of selected biologic action spectra (30° SZA, 2.7mm Ozone) and correlation coefficient R<sup>2</sup> between UV-meter reading and biologic effect.

Action Spectrum	RAF	R <sup>2</sup> vs UV-Bio-meter	R <sup>2</sup> vs RB meter
Typhimurium Killing	2.65	0.944	0.913
DNA Break	1.26	0.9990	0.9909
Erythema	1.24	0.9993	0.9913
DNA-Protein Crosslinks	1.07	0.9988	0.9969
UV-Biometer	1.03		0.995
RB Meter	0.77	0.995	
Phytoplankton Photoinhibition	0.70	0.981	0.9957
Polychromatic Action Spectrum For Higher Plants	0.47	0.965	0.9833

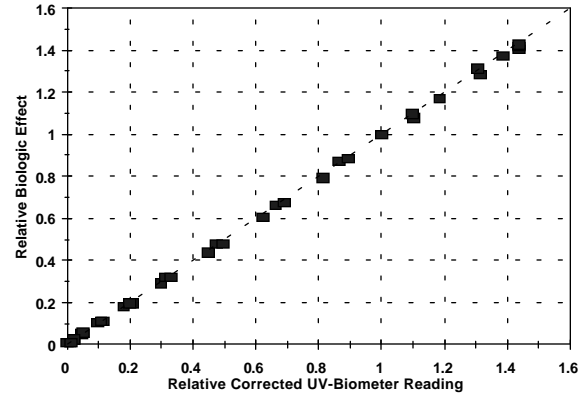

Fig. 12.. Tracking between corrected UV-Biometer readings and spectroradiometrically measured Typhimurium Killing effectiveness on clear day (Dec.27-28, 1992, Lauder, New Zealand, 21.8<SZA<75, AVG Ozone: 280-290DU

The closest to the 45° line are Erythema Action Spectrum, DNA-Protein Crosslinks Action Spectrum and DNA Breaks Action Spectrum. The UV-Biometer tracks them very well for broad range of SZA and ozone layer thicknesses. All action spectra in this category have at least 3 orders of magnitude drop from 280-340nm and then a plateau in the UV-A.

Polychromatic Action Spectrum for Higher Plants and Phytoplankton Action Spectrum have significantly higher UV-A response. As a result the biologic response is convex upwards in respect to the UV-Biometer as zenith angle decreases.

The Typhimurium Killing represents an action spectrum that has virtually no UV-A response. As a result the biologic response is concave down in respect to the UV-Biometer as zenith angle decreases.

The results of computer simulation were used to calculate the correction factors that can be applied to the reading of the UV-Biometer in order to compensate for the spectral differences between the meter and the desired action spectrum. Solar zenith angle and ozone column are input parameters. Figure 11 illustrates an example of such correction factors for Typhimurium Killing Action Spectrum. The calculated correction factors were applied to actual UV-Biometer readings and compared with simultaneous spectroradiometric measurements. Even in the case of an action spectrum extremely different from the meter's response such as Typhimurium Killing the corrected results were in very good agreement with the spectroradiometric measurements (Fig. 12.).



Some action spectra (DNA Breaks, DNA-Protein Crosslinks) do not require any correction since the meter tracks them accurately enough. A Radiation Amplification Factor (RAF) was suggested by Madronich<sup>18</sup> as a simple criterion that might determine whether the meter will track the action spectrum. The RAF is defined as the ratio of the change in effective energy in respect to the change in ozone thickness. A comparison of RAF shown in Table 1 illustrates also the fact that action spectra with RAF close to that of UV-Biometer will follow the meter's readings.

## 5.2. Cosine response considerations

It is conceivable that the cosine response might not be suitable for all biologic measurements. The usual position of the subject, the environment or the process itself may not conform to the cosine law. The question should be raised whether additional measurements with the use of non-horizontally positioned detectors should be started? Except for the marine environment this issue has not yet been defined and we would like to bring it to the attention of photobiologic community.

## 6. CONCLUSIONS

The UV-Biometer, an inexpensive, but stable and reliable broad band meter can be successfully used to monitor the biologic effectiveness of solar ultraviolet radiation.

The RAF of an action spectrum indicates how well the meter and the biologic effect will track each other. If needed, a correction can be made on the basis of solar zenith angle and ozone thickness. The solar zenith angle can be calculated from date, time and latitude. The average ozone layer for the day can be obtained from satellite measurements.

## 7. REFERENCES

1. K. Slomka, "UV-B global radiation in Warsaw and Belsk" *Publs. Inst. Geophys. Pol. Acad. Sc.*, D-7 (126), Warsaw 1978
2. F. Urbach and R.W. Gange, The Biological Effects of UVA Radiation, Chapter 2, Praeger Publishers, New York, 1986
3. A. McKinlay and B.L. Diffey, "A reference action spectrum for ultraviolet induced erythema in human skin". In Human Exposure to Ultraviolet Radiation: Risks and Regulations, (Edited by W.F. Passchier and B.F.M. Bosnjakovic), pp.83-87, Elsevier, Amsterdam, 1987.
4. M.J. Peak and J.G. Peak, "DNA-to-protein crosslinks and backbone breaks caused by far- and near-ultraviolet, and visible radiations in mammalian cells". In Mechanisms of DNA Damage and Repair. Implications for Carcinogenesis and Risk Assessment, (Edited by M.G. Simic, L. Grossman and A.C. Upton), pp.193-202, Plenum Press, New York, 1986.
5. M.J. Peak, J.G. Peak and B.A. Carnes, "Introduction of direct and indirect single-strand breaks in human cell DNA by far- and near-ultraviolet radiations: Action spectrum and mechanisms.", *Photochem. Photobiol.*, 45, pp.381-387, 1987.
6. M.M. Caldwell, L.B. Camp, C.W. Warner and S.D. Flint, "Action spectra and their key role in assessing biological consequences of solar UV-B radiation", In Stratospheric Ozone Reduction, Solar Ultraviolet Radiation and Plant Life, (Edited by R.C. Worrest and M.M. Caldwell), pp.87-111, Springer, Heidelberg, 1986.
7. B.G. Mitchell, "Action Spectra for ultraviolet photoinhibition of Antarctic phytoplankton and a model of spectral diffuse attenuation coefficients", In Response of Marine Phytoplankton to Natural Variations in UV-B Flux, (Edited by G. Mitchell, I. Sobolev and O. Holm-Hansen), *Proc. of Workshop, Scripps Institution of Oceanography*, La Jolla, CA, April 5 1990.

12. B.C. Kennedy and W.E. Sharp, "A Validation Study of the Robertson-Berger Meter", *Photochem Photobiol.*, 56, pp.133-141, 1992
13. J. DeLuisi, "Robertson-Berger Meter Network and Instrument Characterization", *Proc. of UV-B Monitoring Workshop: A Review of the Science and Status of Measuring and Monitoring Programs*, Washington DC, 10-12 March 1992,
14. M. Blunthaler, W. Ambach, M. Morys and J. Slonka, "Comparison of Robertson-Berger UV Meters from Innsbruck and Belsk", *Publs. Inst. Geophys. Pol. Acad. Sc.*, D-32 (230), Warsaw, 1989.
15. A.E.S. Green, K.R. Cross and L.A. Smith, "Improved Analytic Characterization of Ultraviolet Skylight", *Photochem Photobiol.*, 31, pp.59-65, 1980.
16. Global Atmosphere Watch, WMO Global Ozone Research and Monitoring Project, No. 22, WMO Consultation on Brewer Ozone Spectrophotometer Operation, Calibration and Reporting, Arosa, Switzerland, 2-4 August 1990.
17. R.L. McKenzie, P.V. Johnston, M. Kotkamp, A. Bittar, and J.D. Hamlin, "Solar ultraviolet spectroradiometry in New Zealand: instrumentation and sample results from 1990", *Applied Optics*, Vol 31, No. 30, pp.6501-6509, 20 October 1992.
18. S. Madronich, Suggestion at UVB Workshop, Feb. 1993