

# Table of contents.

1 Introduction.....	2
501 UV-B iometer Version 1.0 features.....	2
Technical specifications.....	2
About this manual.....	7
2 Installation.....	8
Installing the detector.....	8
Supplying power for the 501 UV-B iometer.....	9
Installation hints.....	9
3 Setting up the recorder.....	11
Navigating the menu.....	11
Display.....	13
Printout.....	15
Recording.....	15
Date and time.....	16
Communication.....	17
Measurement.....	17
Utilities.....	19
Default settings.....	20
4 Connecting peripherals.....	21
Printer.....	21
Computer.....	23
Modem.....	27
5 Maintenance.....	29
Watchman.....	29
Alarms and error messages.....	29
Cleaning and changing the internal batteries.....	30
Troubleshooting.....	31
6 Data interpretation and calibration.....	33
7 Principles of operation.....	34

## Appendices

Copyright 2006, All rights reserved

# 1 Introduction

The 501 UV-B iometer is the continuation of the line of Robertson-Berger Weatherproof meters, that have been employed in the worldwide network for UV-B monitoring. The UV-B iometer has been designed by D.Berger and M.Morys, based on the experience gained during the Robertson-Berger meter design (Berger 1976) and of research focused on the temperature dependency and stabilization of the Robertson-Berger UV-B sensor (Blumthaler, Ambach, Morys, Slomka 1989).

## 1.1 501 UV-B iometer Version 1.0 features

- compact, light-weight detector and recorder,
- the recorder with two detector inputs,
- spectral response close to erythema and other action spectra,
- temperature stabilization of the phosphor (when AC line available),
- menu organized dialogue with user,
- internal nonvolatile data buffer (3½ month capacity @ 30 min interval),
- low power consumption, internal batteries for 2 days of operation,
- built in temperature correction of the phosphor (for extreme conditions),
- alphanumeric LCD and keypad on the recorder,
- flexible setup of most measurement and recording parameters,
- parallel printer interface,
- serial interface for computer,
- easy dialogue with computer (setup and data transfer),
- remote control using modem.

## 1.2 Technical specifications

### A. Detector

Spectral response	<b>Figure 1</b>
Angular response (follows cosine law)	<b>Figure 2</b>
Readout range	0...9.99 MED/HR
Resolution	better than 0.01 MED/HR

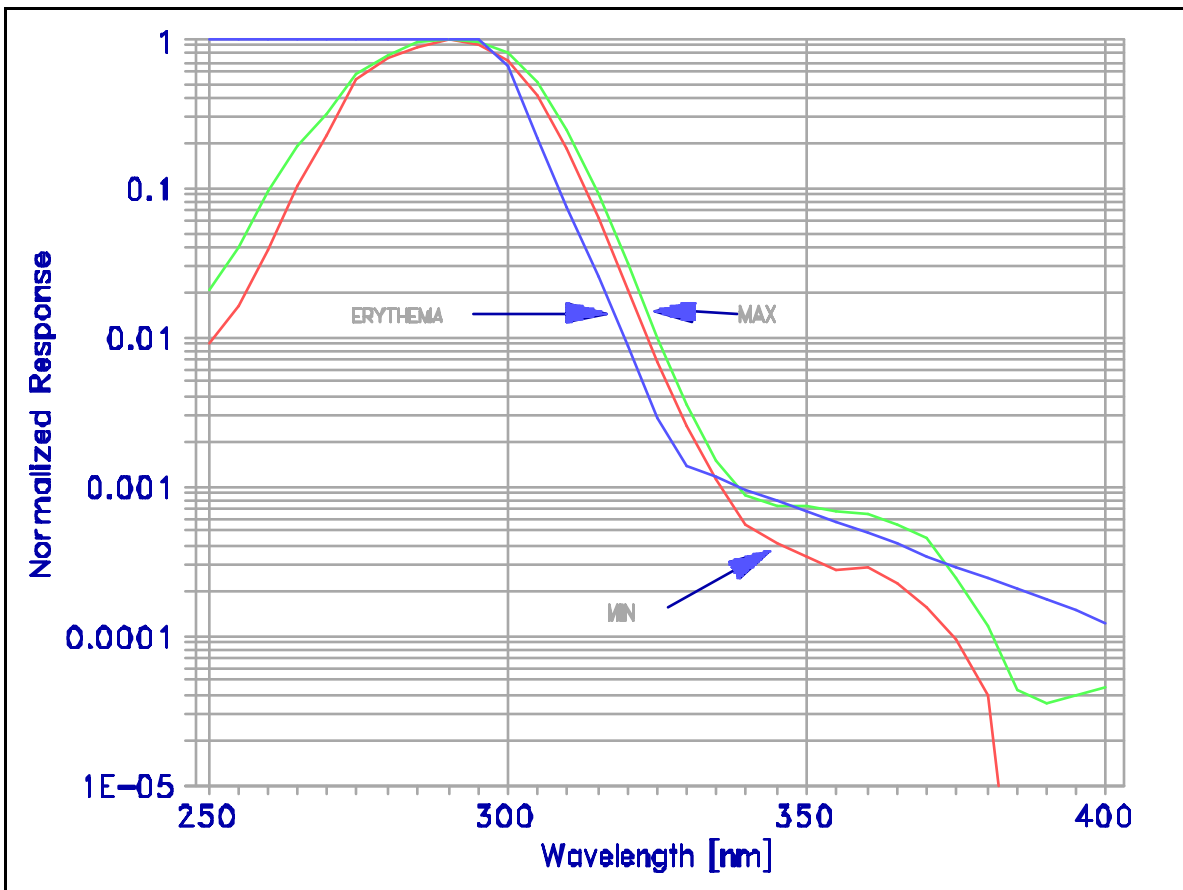

**Figure 1** Spectral response of 501 UV-Biometer detector.

Accuracy	within +/- 5% for daily total
Outputs	+/-5V pulses, frequency depending on UV-B or temperature
Power consumption ...	10 mA/5V
Operating environment	outdoor
Operating ambient temperature	-20...50°C
Storage temperature....	-40...70°C
Temperature sensor measurement range	-50...100°C
Thermal drift of zero (vs.ambient temp.)	< 25*10 <sup>-5</sup> (MED/HR)/°C

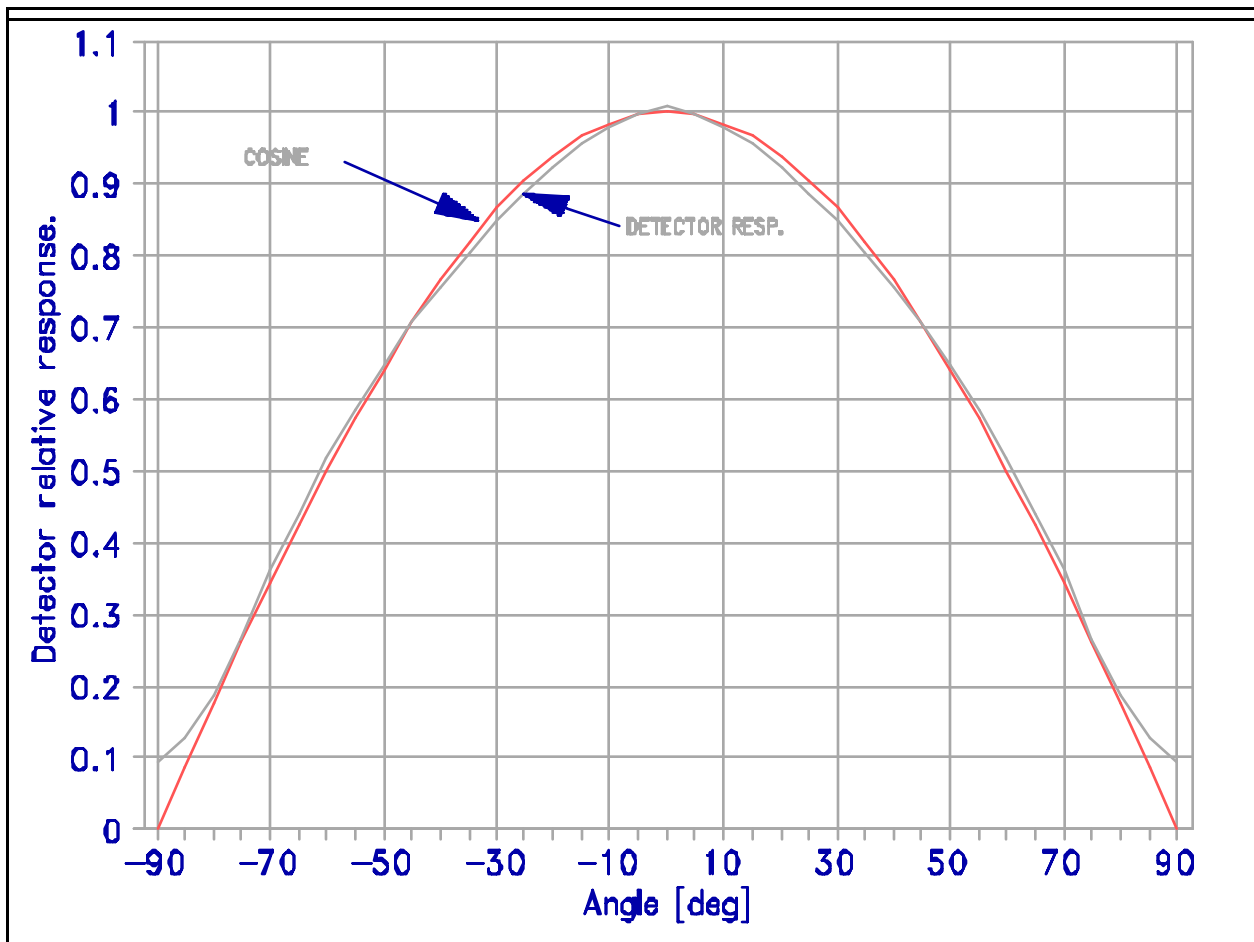

**Figure 2** Angular response of the detector.

Temperature stabilization of the phosphor :

max. temperature differential:

heating above ambient

50°C

cooling below ambient

20°C

stabilization accuracy

0.2°C

temperature settling time

<5 minutes @ 20 °C change

temperature settling curve

**Figure 4**

power requirements

approx. 10 W / detector

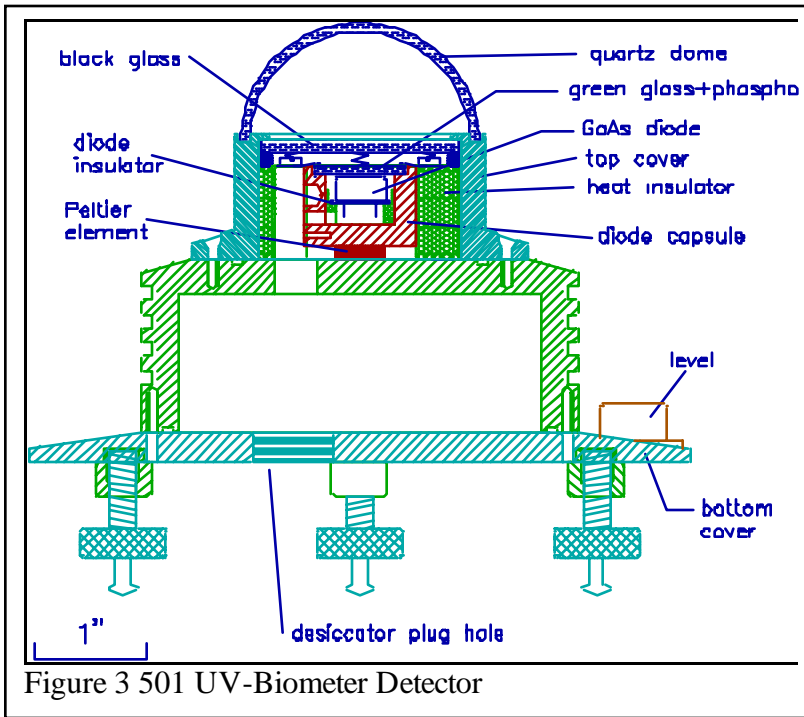

Cable length	300 ft. (100m) max. 50 ft. (15m) standard
Diameter	6" (15 cm) max.
Height	approx. 5" (13 cm)
Weight	2 lbs. ( 0.9kg)
The detector housing	Figure 3

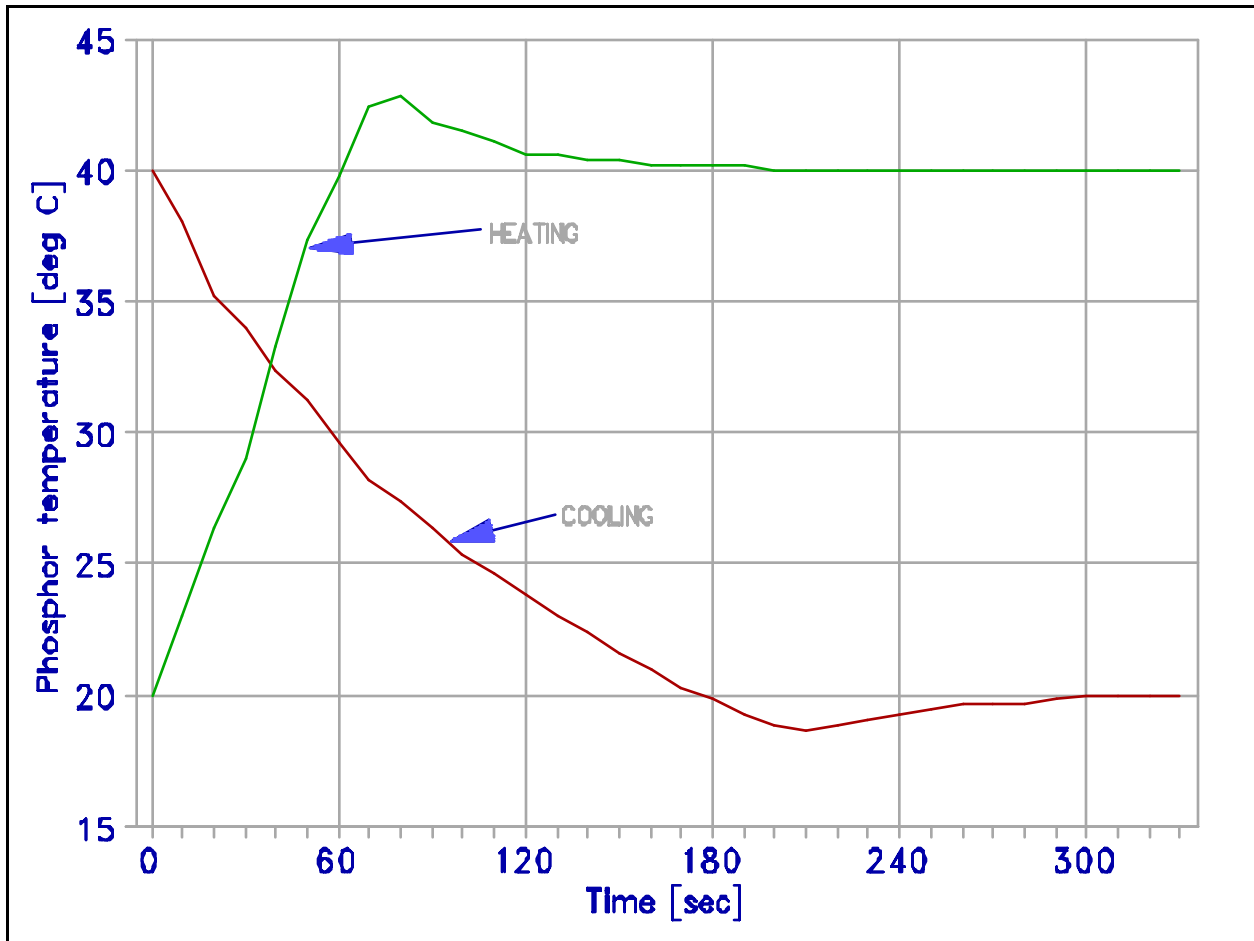

**Figure 4** Phosphor temperature settling time.

**B. Recorder**

Number of simultaneously serviced detectors	2
Setup	from keypad or computer
Integrating interval	selectable : 1, 2, 3, 4, 5, 6, 10, 12, 15, 20, 30, and 60 minutes
Stored SUV dose resolution	0.001 MED
Stored temperature resolution	1 °C
Data storage capacity (max)	5248 blocks of SUV and temperature from 2 det. ( 3.5 month @ 30 min. interval)
Real time clock drift	< 1 min/month
Display	alphanumeric LCD, two lines of 16

	characters
Detector inputs :	
connector	9 pin D - male (see Appendix for pin description)
power for the detector	5 V fused 100 mA
signal inputs	+/-5V pulses, frequency changing with UV-B and temperature, protected up to 200 V
Printer interface :	
standard	parallel
internal buffer capacity	256 bytes
connector	25 pin D - female
max. cable length	20 ft. (6.4m)
Serial interface :	
connector	9 pin D - female (see Appendix for pin description)
speed	selectable 300, 600, 1200, 2400, 4800, or 9600 baud
word length	8 bits
parity	none
stop bits	1
handshake	none
terminal emulation	ANSI BBS
local echo	OFF (full duplex)
serial port buffer (input & output)	128 bytes each
max. cable length	depends on speed - 30 ft (9m) for 9600 baud
Power requirements	110/250 VAC, 0.6/0.3 A 50 or 60 Hz or 4...15 V DC / 150 mA min
Dimensions (WxHxD)	6.3"x3.1"x9.5" (16x8x24 cm)

Weight

4 lbs. (1.8kg)

### **1.3 About this manual**

This manual has been designed for various user needs - you can read as much or as little as you like. The manual contains the following sections:

- Introduction
- Installation
- Setting up the recorder
- Connecting peripherals
- Maintenance
- Calibration
- Principles of operation
- Appendices

These sections provide logical separations of the information needed to get the most from the 501 UV-B iometer. They cover aspects related to UV-B iometer usage, beginning from basic installation procedure and ending on some examples of calculations and interpretation of measured quantities.

This special sign emphasizes the warnings, helpful hints and other important information that will help you get better use from the UV-B iometer.



## 2 Installation

Proper installation of the detector and recorder assures accurate measurement of the UV-B radiation. Note, that the detector is designed for outdoor operation, while the recorder can work at room conditions only.

### 2.1 Installing the detector

To obtain correct readings placement of the detector must meet the following criteria:

- As much of the whole sky as possible should be visible from the detector location. Diffused radiation from the entire sky contributes significantly to the UV-B.
- Dust or smoke from vents or chimneys may cause substantial change of the UV-B radiation reaching the detector.
- The detector shouldn't be located in places where snow or water tends to accumulate.
- Locating the detector together with equipment that needs frequent service may result in incorrect dose measurement since it will be disturbed by personnel blocking the light.
- A lightning rod should be installed within 2 to 4 meters if the detector is exposed on the top of a high building or in an area where thunderstorms are frequently observed.

A detector base is provided to hold the detector in its selected place. The construction of the base allows levelling the detector after it is mounted. The bottom plate of the base has 3 countersunk holes (B in 4) to fasten the base using flathead screws. After the base is fastened, align the top plate with the bottom one as shown in 4. Insert the tripod legs into the three openings (A in 4) and rotate the top plate clockwise locking the detector.

After the detector is mounted, plug in the weatherproof cable connector. Screw it in firmly. Level the detector, if necessary. The detector cable should be protected against damage.

### 2.2 Supplying power for the 501 UV-B iometer

The power for the detector and recorder (except the thermostat) is supplied from internal batteries which are permanently charged from an external source. This assures uninterrupted operation in case of external power failures. A fully charged battery will supply the recorder with one detector for at least 1 day. The **EXT. POWER** indicator at the front panel of the recorder lights when the external power is available. Described below are two ways to supply the power to the 501 UV-B iometer:

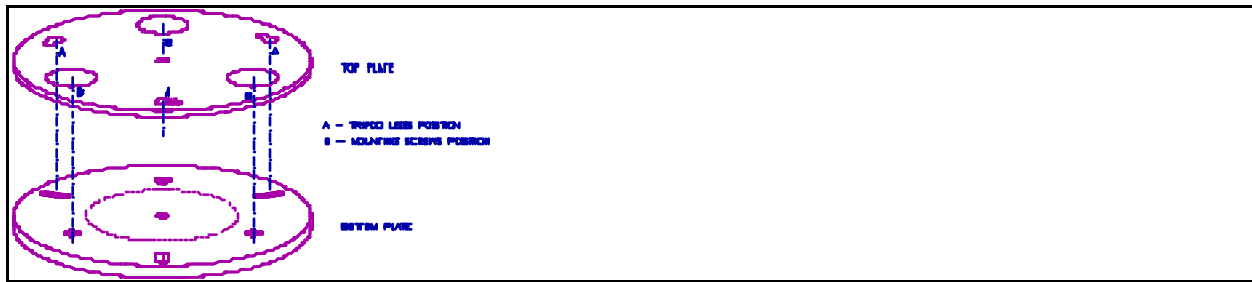

**Figure 5** Mounting the detector base.

- An AC line is available :  
Plug in the power cord into the line socket (see tech. specs.). Make sure that the protective ground pin is properly connected. In this configuration the AC power supply charges the internal batteries and powers the thermostat stabilizing the detector temperature.
- Other sources of power :  
The 501 UV-B iometer can be externally supplied from a 4 to 15 VDC source with a minimum 150 mA driving capability (optimum 4 to 6V). The internal circuitry limits the battery charging current to about 250 mA. The temperature stabilization of the detector is not available in this case since its power requirements are high.

Note, that the power switch at the back of the recorder disconnects only the DC voltage, NOT the AC line. If the 501 UV-B iometer is not to be used for a long time (days or weeks) unplug the AC cable from the wall outlet.

## **2.3 Installation hints**

This paragraph provides information about procedures which, if not observed, could result in damage to the equipment or personal injury.

- Read the instruction describing installation (¶ 0).
- Unplug the AC cable from the wall outlet before cleaning, battery changing or repairing. For the recorder, do not use liquid or aerosol cleaners.
- Slots on the top and bottom of the recorder are provided for ventilation. Do not block or cover this openings (for ex. by placing the recorder on a soft surface).
- Power supplies must be 110-250 VAC or 4-15 VDC (see technical specs.).
- The recorder is equipped with a 3-wire plug having a grounding pin. If you are unable to insert the plug into the outlet, contact your electrician to replace your unusable outlet. Do not defeat the safety purpose of the grounding. All externally accessible metal parts of the recorder, and the detector case are connected together and to the grounding pin.
- Except as explained elsewhere in this manual, don't attempt to service this product yourself.
- Unplug the recorder from the wall outlet and refer servicing to qualified service personnel for the following conditions:
  - A. the power cord or plug is damaged,
  - B. liquid has been spilled into the recorder,
  - C. the recorder cabinet has been damaged,
  - D. the product exhibits a distinct change in performance.

## 3 Setting up the recorder

The front panel keypad (6) or an external computer (see ¶ 0) can control functions and setup of the UV-Biometer. Settings are non-volatile, that is they are not altered by losing power or turning the power off.

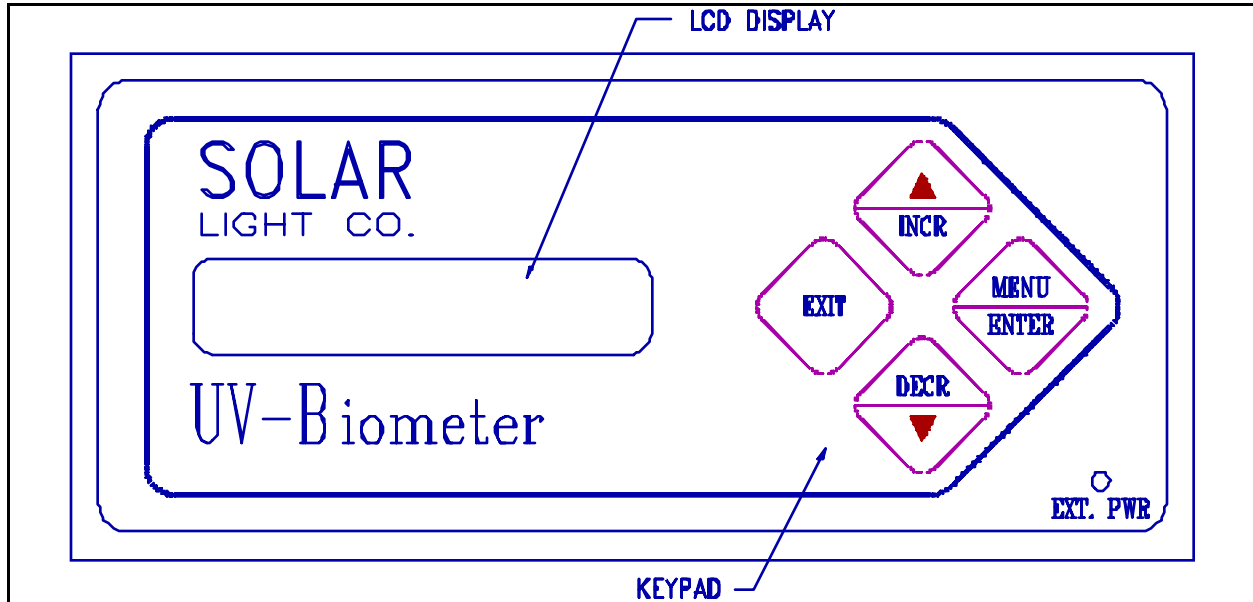

**Figure 6** Front panel of the 501 UV-Biometer recorder.

### 3.1 Navigating the menu

The recorder is in the **DISPLAY MODE** while the LCD shows measured values or time (the LCD contents are selectable - ref. 0). Pressing the **MENU/ENTER** key the user switches to **MENU MODE** and the LCD shows selected items from the menu.

Dialogue with the user is organized in a multilevel menu structure (see 1 and Appendix). All items are logically separated into categories. Generally, the functions of the four keys on the keypad are as follows:

**MENU/ENTER** enters **MENU MODE** when in **DISPLAY MODE**; transfers to lower level menu while in any menu; selects item from choice list

**EXIT** exits current menu and transfers control to the menu one level higher or to **DISPLAY MODE** (does not cancel any changes to settings made while in lower level menu), selects **WATCHMAN** when in **DISPLAY MODE**

**INCR/▲** scrolls up while in any menu or choice list and increments when changing any numeral settings (for ex. hours or scale),

**DEC/▼** scrolls down while in any menu or choice list and decrements when changing any numeral settings

All groups of items in 1 that are surrounded by boxes represent menus, and pressing **INCR/▲** or **DECR/▼** key scrolls through it. When the top item is selected, pressing the **INCR/▲** key moves the control to the very bottom selection (all items are organized in a loop). Consequently, the **DECR/▼** key shifts control from the very bottom item to the very top one. Note, that every item can be reached scrolling the menu either up or down. Horizontal lines in the 1 show the possible ways of control transfer between menus, using the **MENU/ENTER** and **EXIT** keys.

Using the menu system does not interfere with the measurement, recording or communication in progress if the user does not intentionally change any settings that directly affect those processes (for ex. time or offset or baud rate).

**EXAMPLE : Changing the recording and printing interval.**

Pressing the **MENU/ENTER** key while in the display mode causes transfer to the **MENU MODE** and the LCD shows:

```

.....
.   - MAIN MENU -   .
.   -  DISPLAY  -   .
.....

```

Pressing the **DECR/▼** key twice moves us to the **RECORDING** item on the LCD:

```

.....
.   - MAIN MENU -   .
.   - RECORDING -   .
.....

```

Now, pressing the **MENU/ENTER** key shifts control to the first item of the **RECORDING** sub-menu, that is **RECORDING ON/OFF** as indicated on the LCD :

```

.....
.   - RECORDING -   .
. RECORDING ON/OFF .
....._.....

```

Since the **CHANGE INTERVAL** function is next below, the **DECR/▼** key needs to be pushed. Now the display shows:

```

.....
.   - RECORDING -   .
. CHANGE INTERVAL .
.....

```

Pressing the **MENU/ENTER** transfers the control to the interval changing procedure and the LCD shows:

```
.....  
•   INCR/DECR INTERV   •  
•   INTERVAL= 12 MIN   •  
.....
```

Pressing the **INCR/▲** (or **DECR/▼**) key increments (decrements) the interval to these displayed values (i.e. 1, 2, 3, 4, 5, 6, 10, 12, 15, 20, 30 and 60 minutes). After the desired value is chosen, pressing the **EXIT** key three times (one level at a time) shifts the control to **DISPLAY MODE**.

Subsequent paragraphs explain in detail the menu structure and the purpose of all functions. The titles of the paragraphs correspond to main menu components, see 1.

**Table I** 501 UV-Biometer menu structure

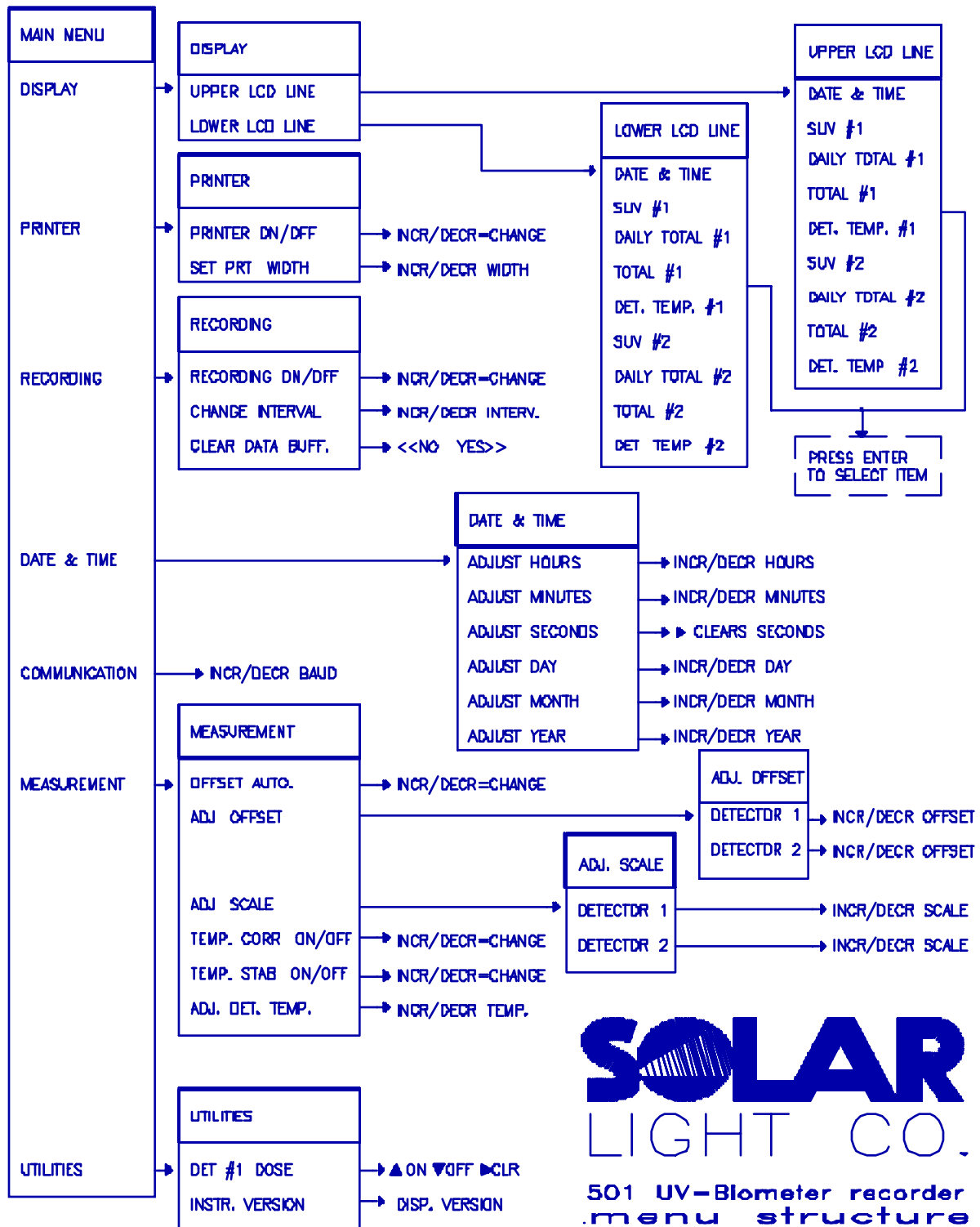

**3.2 Display**

This option allows the user to customize the function of the LCD in the DISPLAY MODE. Since there are only 2 lines, each 16 characters long, and 9 quantities can be measured or calculated, the user must choose those to be displayed. The upper and lower LCD lines are setup separately, each of them displaying one of the following quantities:

- date & time
- SUV intensity ( Sunburn UV in MED/HR) from the detector no. 1
- daily total for the detector no. 1
- total for the detector no. 1
- temperature of the detector no. 1
- SUV intensity ( Sunburn UV in MED/HR) from the detector no. 2
- daily total for the detector no. 2
- total for the detector no. 2
- temperature of the detector no. 2

The key sequence to reach the choice list for the upper LCD line from the **DISPLAY MODE** is:  
**MENU/ENTER MENU/ENTER MENU/ENTER**

The sequence for the lower LCD line is :  
**MENU/ENTER MENU/ENTER DECR/▼ MENU/ENTER**

After the selection from the choice list is made (using the **INCR/▲** or **DECR/▼** keys), pressing the **MENU/ENTER** key makes that selection effective and permanent (until the next selection is made) and transfers control to the menu one level up. Leaving the choice list with the **EXIT** key does not change previous display settings!

### **3.3 Printout**

There are two items in the PRINTER menu (see ¶ 0 for other printer related information):

- **PRINTER ON/OFF** Enables/disables the on-line printout. If the printout was OFF then turning it ON causes the header to be printed (the same header is also printed every midnight). When the printout is enabled an additional message is also generated if there has been a power failure. The date and time of the outage is printed next time the unit is powered ON). The **INCR/▲** and **DECR/▼** keys enable and disable the printer (change is effective immediately) and the current printer status is displayed when using this function. The **MENU/ENTER** and **EXIT** keys return the control to the menu one level up.



- **SET PRT. WIDTH** Allows the user to define the line width of the printer. If the width is between 16 and 39 characters inclusive a short form printout is generated. The **INCR/▲** and **DECR/▼** change the printer width (change is effective immediately) and the current width is displayed when using this function. The **MENU/ENTER** and **EXIT** keys return the control to the menu one level up.

The key sequence to reach the PRINTER ON/OFF function, from the **DISPLAY MODE** is:  
**MENU/ENTER DECR/▼ MENU/ENTER MENU/ENTER**

The same for the PRINTER WIDTH is :

**MENU/ENTER DECR/▼ MENU/ENTER DECR/▼ MENU/ENTER**

The recording of data and the printout are simultaneous. Refer to ¶ 0 for changing the interval.

### 3.4 Recording

Measured UV-B intensity and temperature from two detectors are stored in the internal nonvolatile circular buffer. There is space for 5248 records. One record contains full information from 2 detectors. If the meter is turned OFF frequently the buffer usage effectiveness is reduced. When the buffer is full, and new data are to be recorded, 41 records containing the oldest data are emptied and the space is allocated for current recording. If that data are not copied to the computer they will be lost (ex: for 30 min integrating interval the buffer capacity is about 3½ months so in this case the data must be transferred to the host computer at least every 3½ months). In the buffer, there can coexist data recorded with different intervals and they will be properly marked when transferred to the computer.

The following functions are available in the RECORDING menu :

- **RECORDING ON/OFF** Enables and disables the recording. If the recording were OFF, and then is turned ON, the first record will be stored in memory at the full minute that can be divided by the interval without a remainder. This allows recording which will always have a readout at the full hour. The **INCR/▲** and **DECR/▼** change the recording status (effective immediately) and the current status is displayed when using this function. The **MENU/ENTER** and **EXIT** keys transfer the control one level up.

- **CHANGE INTERVAL** Allows the user to change the frequency of printing and storing data from both detectors. Only those values, that multiplied by an integer fit into one hour, are allowed (i.e. 1, 2, 3, 4, 5, 6, 10, 12, 15, 20, 30, 60 minutes). Interval changing is disabled when the recording is ON. To start the recording with a new interval, the current recording must be turned off, then the interval can be changed and a new recording initiated. The **INCR/▲** and **DECR/▼** change the recording interval (effective immediately) and the current interval is displayed when using this function. The **MENU/ENTER** and **EXIT** keys transfer the control one level up.
- **CLR DATA BUFFER** Empties all data from the buffer. This function is disabled when the recording is ON. The user is prompted for confirmation before buffer is cleared. The **EXIT** key cancels the operation and returns control to the menu one level up. The **MENU/ENTER** key continues the operation, immediately clears data buffer, and returns control to the higher level menu. Other keys are inoperative.

The key sequence to reach the RECORDING ON/OFF function, from the **DISPLAY MODE** is:

**MENU/ENTER DECR/▼ DECR/▼ MENU/ENTER MENU/ENTER**

The same for the CHANGE INTERVAL is :

**MENU/ENTER DECR/▼ DECR/▼ MENU/ENTER DECR/▼ MENU/ENTER**

The same for the CLEAR DATA BUFFER is :

**MENU/ENTER DECR/▼ DECR/▼ MENU/ENTER DECR/▼ DECR/▼  
MENU/ENTER**

### 3.5 Date and time

The 501 UV-B iometer has an internal real time clock that keeps the date and time even if the meter is turned OFF. Nevertheless, it is strongly advised to check (and eventually adjust) the date each time the unit is turned ON, and at least every month while in operation. During normal operation the clock takes leap year into account, but when it is turned OFF it does not. If the meter is recording data, the time adjustment should be made in the middle between the recordings. The reason is the possibility of missing a sample when the adjustment causes a "time gap" (example: adjusting from 12:29 to 12:31 will lose the data which would have been stored at 12:30). If major time or date adjustment is necessary, the recording should be turned OFF before adjustment, and then turned back ON.

All components of the date and time can be changed separately. The adjustment procedure is the same for all of them, except seconds.

- **ADJUST HOURS** After this function is selected the current date and time is displayed and the **INCR/▲** and **DECR/▼** keys can be used to increment or decrement the selected component of the date and time. The value (hours in this case) will change only within the valid range. The change has immediate effect, regardless of which key is used to leave this function (**MENU/ENTER** or **EXIT**).
- **ADJUST MINUTES** as above
- **ADJUST DAY** as above
- **ADJUST MONTH** as above
- **ADJUST YEAR** as above
- **ADJUST SECONDS** The seconds can be cleared only (set to 00) using the **MENU/ENTER** key. The **EXIT** key shifts control to the upper menu. Other keys are ignored.

The key sequence to reach the ADJUST HOURS function, from the **DISPLAY MODE** is:

**MENU/ENTER DECR/▼ DECR/▼ DECR/▼ MENU/ENTER MENU/ENTER**

The same for the ADJUST MINUTES is :

**MENU/ENTER DECR/▼ DECR/▼ DECR/▼ MENU/ENTER DECR/▼  
MENU/ENTER**

The key sequence to get to DAY, MONTH and YEAR is straightforward extrapolation of the above two examples.

### 3.6 Communication

Currently the COMMUNICATION menu performs only one function - changing the transmission speed for the serial port, which can vary from 300 to 9600 baud. The **INCR/▲** and **DECR/▼** keys scroll through the available values, and the current baud rate is displayed on the LCD. The change is immediate, so be sure not to change this parameter when the communication with the computer is in progress. Either **MENU/ENTER** or **EXIT** keys transfer the control to the MAIN MENU, leaving the baud rate at the last selected value. Refer to ¶ 0 to get some more information about the serial communication and how to control the 501 UV-B iometer from the host computer.

The keys sequence to reach the COMMUNICATION function, from the **DISPLAY MODE** is:

**ENTER INCR/▲ INCR/▲ INCR/▲ MENU/ENTER**

### 3.7 Measurement

Functions grouped into this menu allow the user to setup parameters which change the measurement conditions. Generally, the displayed value  $SUV_{disp}$  of the intensity is calculated according to the formula:

Install Equation Editor and double-click here to view equation. **(1)**

where the  $SUV_{meas}$  is the measured value, SCALE and OFFSET are system variables that can be altered by the user, and TCORR is the temperature correction factor discussed later in this paragraph. There is separate set of those system variables for each detector.

- **OFFSET AUTO.** Turns ON or OFF the automatic adjustment of the OFFSET for both detectors. The offset may exhibit drift due to temperature or time. When the OFFSET AUTO is ON, the recorder adjusts the system offset variable at midnight, forcing the meter to read zero. This feature should be turned off in areas where the UV-radiation does not drop to zero at midnight.
- **ADJ. OFFSET** When manual adjustment of the offset for either detector is required, selecting this item shifts the control to the detector selection menu. After the desired detector is selected press **MENU/ENTER** key. The **INCR/▲** and **DECR/▼** keys increment and decrement the OFFSET with a 0.001 [MED/HR] step in the range of -1...1 [MED/HR]. Any change immediately affects the displayed UV-B sensitivity. After one OFFSET is adjusted, the **MENU/ENTER** or **EXIT** keys return the control to the detector selection menu and the

operation can be repeated for the second detector.

- **ADJ. SCALE** The 501 UV-B iometer can change the scale factors, independently for both detectors. The adjustment procedure is similar to that described for OFFSET adjustments. The SCALE can be changed in the range -10...10, with a 0.001 step. Initially the SCALE is set to 1, since the detector is factory calibrated. Any change immediately affects the displayed UV-B intensity (ref. ¶ 0 for additional information).
- **TEMP.CORR.ON/OFF** This toggle switch (either **INCR/▲** or **DECR/▼** complements the status) turns ON or OFF the correction of the temperature dependence of both detectors. Temperature correction is provided for those conditions where temperature stabilization is impossible or insufficient (extremely high air temperature and high insolation). Currently, the temperature correction is made assuming a linear temperature coefficient, which is a good approximation for most conditions. The TCORR factor used in 1 is equal to 1 when the temperature correction is OFF. Otherwise it is calculated according to the formula:

$$TCORR = 1 + (T_{det} - T_{nom}) * \epsilon_T \quad (2)$$

where the  $T_{nom}$  and  $T_{det}$  are the nominal temperature of the detector (at which it was calibrated) and the actual detector temperature respectively. The  $\epsilon_T$  is the thermal coefficient of the detector, 0.9% / °C in this case (ref. literature for more details about temperature dependence of the detector). The temperature correction and stabilization can be turned ON simultaneously, so that the temperature correction is effective when the stabilization is insufficient. Since the detector temperature is also recorded, it is possible to keep track of the temperature correction of the data.

- **TEMP.STAB.ON/OFF** Turns ON or OFF the stabilization of the phosphor temperature. The PID regulator routine executed by the processor assures fast settling time and good accuracy of the temperature stabilization.
- **ADJ. DET. TEMP.** Allows setting the temperature at which both detectors will be maintained (the **INCR/▲** and **DECR/▲** keys increment and decrement the temperature). Any temperature between -10 and 50 °C is accepted, with 1 °C steps. Selecting too low or too high temperature will not allow the thermostat to maintain the temperature in certain conditions (25°C is recommended). Refer to technical specifications for the temperature stabilization parameters.

The key sequence to reach the OFFSET AUTO. function, from the **DISPLAY MODE** is:

**MENU/ENTER INCR/▲ INCR/▲ MENU/ENTER MENU/ENTER**

For the ADJ. OFFSET:

**MENU/ENTER INCR/▲ INCR/▲ MENU/ENTER DECR/▼ MENU/ENTER**

The key sequence to get to other items in this menu is a straightforward extrapolation of the above two examples.

### 3.8 Utilities

Additional functions are provided to increase the functionality of the 501 UV-B iometer:

- **DET. #1 DOSE** This is the dose integrator and it can be turned ON, OFF or cleared at any time. It integrates the UV-B dose that was measured by detector no. 1. The keys have the following functions:  
**INCR/▲** - start/continue integrating  
**DECR/▼** - stop integrating  
**MENU/ENTER** - clear dose counter  
**EXIT** - exit the menu controlling this function - does not affect the dose counter, which continues the integration process in the background, if it was ON.
- **INSTR. VERSION** Displays the current version of the instrument. Since the instrument is microprocessor based, a software change can result in new features and parameters. The user can check the current version of the instrument by selecting this function. This instrument version should be referred to when contacting the manufacturer.

The key sequence to reach the DET #1 DOSE function, from the **DISPLAY MODE** is:

**MENU/ENTER INCR/▲ MENU/ENTER MENU/ENTER**

For the INSTR. VERSION :

**MENU/ENTER INCR/▲ MENU/ENTER DECR/▼ MENU/ENTER**

### 3.9 Default settings

When the instrument comes from the manufacturer, the settings are as follows:

#### DISPLAY:

UPPER LCD LINE: DATE & TIME

LOWER LCD LINE: SUV #1

#### PRINTER:

PRINTER ON/OFF: ON

PRINTER WIDTH: 40

#### RECORDING:

RECORDING ON/OFF: ON

REC. INTERVAL: 30 min

DATE & TIME: local time for the customer site

#### COMMUNICATION:

BAUD RATE: 2400 (no parity, 8 bits, 1 stop)

#### MEASUREMENT:

OFFSET AUTO: ON

ADJ. OFFSET: 0

ADJ. SCALE: 0

TEMP.CORR.ON/OFF: ON

TEMP.STAB.ON/OFF: ON

DET. TEMP. : 25°C



## 4 Connecting peripherals

Besides the two UV detectors, some additional peripherals can be connected to the 501 UV-B iometer recorder. This sections describes the details of the communication between the

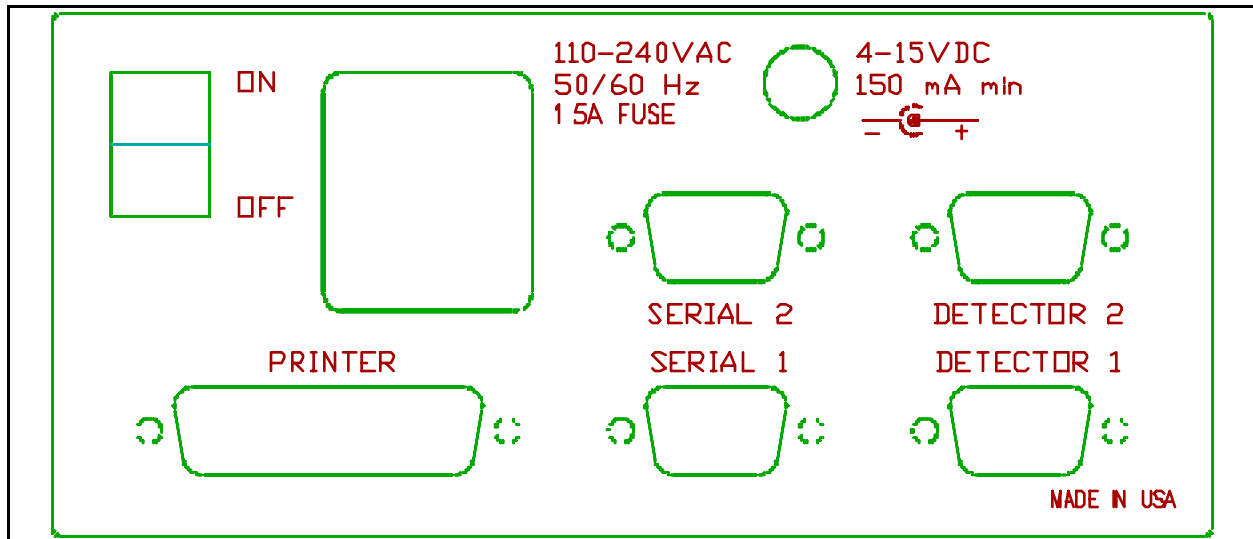

**Figure 7** Back panel of the 501 UV-B iometer recorder.

recorder and peripherals. All connectors are installed on the back panel of the recorder (**Figure 7**).

### 4.1 Printer

Any printer equipped with standard parallel interface (Centronics) can be hooked up to the 501 UV-B iometer (**PRINTER** connector at the back panel). Standard Centronics cable can be used (Figure 8). Refer to appendix for the interface pin description.

Both, the recorder and the printer should be turned OFF before plugging in the cable.

If the printer line width is less than 40 characters across the page, but not less than 16, the recorder should be set to the appropriate printer width (ref. ¶ 0). The printer must be turned ON LINE (usually from the control panel of the printer), and the printout from 501 UV-B iometer must be enabled (¶ 0). Just after the printout is enabled, the header is printed. The paper is advanced to the top of a new page. The same header is printed every midnight. The measured doses are printed simultaneously with the recording. Refer to ¶ 0 to find, how to change the printing and recording interval. The word "WATCHMAN" is printed every time the "Watchman" function is used.

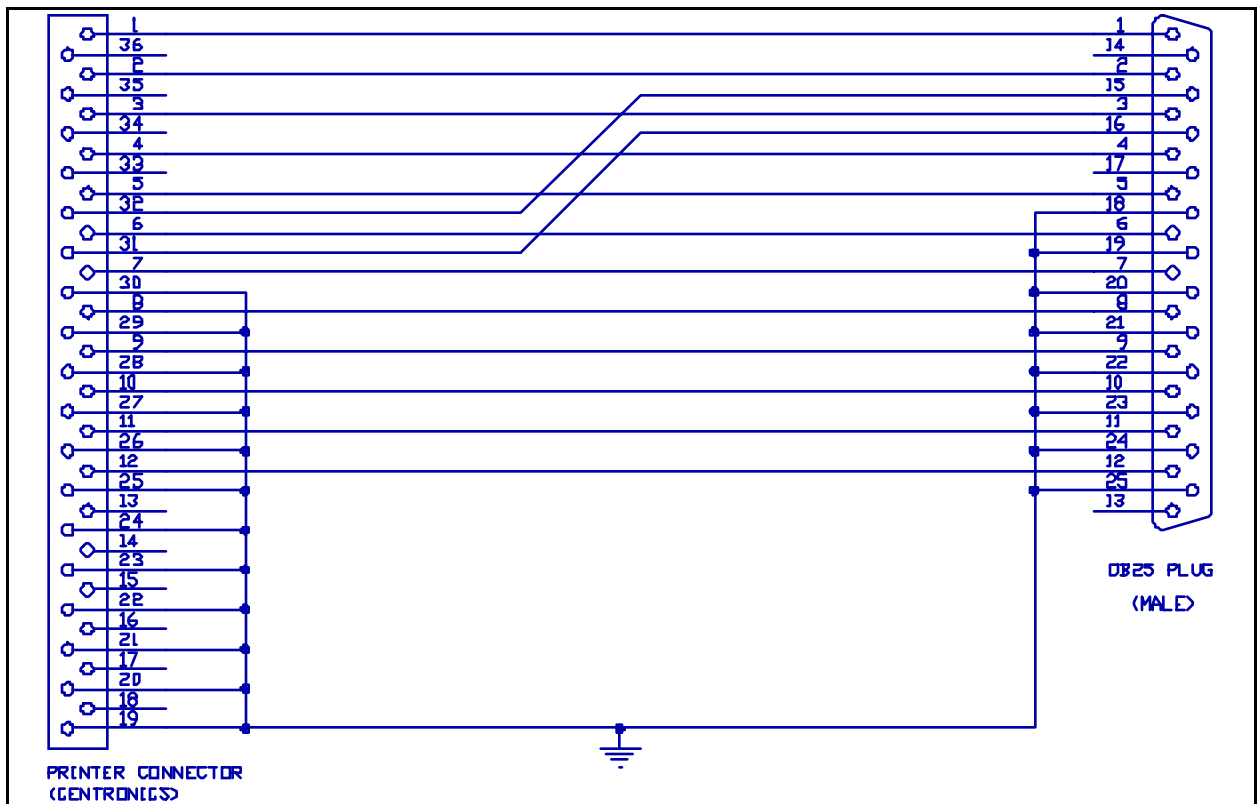

Figure 8 Parallel printer cable.

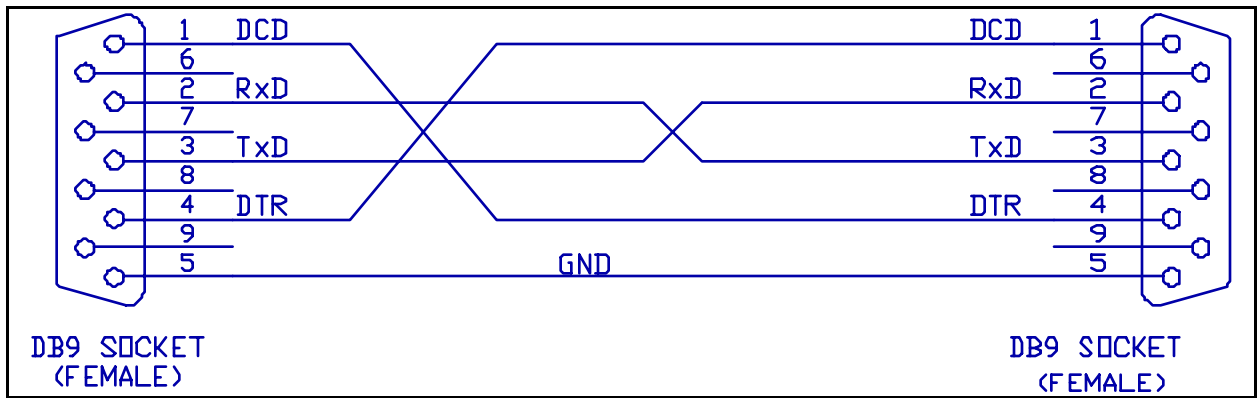

Figure 9 Serial interface cable.

The recorder has an internal printer buffer that is capable of storing up to 6 lines of printout, while the printer is OFF LINE (for ex. to change the paper).

## **4.2 Computer**

The 501 UV-B iometer recorder is specially designed to facilitate communication with the computer. The recorder **SERIAL 1** output can be connected directly to the computer or to a modem (see ¶ 0) using cable wired as in 8. The **SERIAL 2** output is provided for testing purposes and for future options. The maximum length of cable decreases when the communication speed increases, and should not exceed 30ft. (about 9 m) for 9600 baud. An extender from 9 pin to 25 pin connector can be used if needed.

Commercially available communication software can be used to perform the setup or data transfer between computer and the UV-B iometer. The program must be set up for: 8 data bits, 1 stop bit, no handshake, ANSI BBS terminal emulation, no local echo (full duplex), and the speed must match that chosen for the 501 UV-B iometer. Either COM1 or COM2 can be used.

**Table II** 501 UV-Biometer remote setup menu.

---

Solar Light Co. 501 UV-Biometer

=====

Supported functions :

- A - display current values and settings
- B - recording ON/OFF
- C - printing ON/OFF
- D - set the printing & storing interval
- E - clear data buffers
- F - set date & time
- G - offset adjustment
- H - scale adjustment
- I - offset auto-adjustment ON/OFF
- J - temperature stabilization ON/OFF
- K - temperature correction ON/OFF
- L - transfer of recorded data
- M - change detector name

>> Select function ...

---

**Table III** Computer screen displaying current settings of UV-Biometer.

---

Solar Light Co. 501 UV-Biometer S/N 12345  
=====

Date : 18 Apr 1991      Time : 11:35:15

		Det #1	Det #2
		-----	-----
SUV [MED/Hr]	:	1.979	1.987
Det. temperature [degC]	:	20.1	16.1
Daily total [MED]	:	1.737	1.743
Total [MED]	:	258.1	341.0
Offset [MED/Hr]	:	-0.003	0.007
Scale adjustment	:	1.000	1.000

Recording is ON    Sampling interval : 30 min  
First recorded data : 31Mar1991 8:30  
Printer is OFF  
Temperature stabilization is ON  
Temperature correction is OFF  
Offset auto-adjustment is ON

Press any key to return to main menu

---

Note, since there is no handshake, the computer must be able to receive and process all data at full speed. When logging the incoming data on the disk, the disk service slows down the capability of receiving information and the serial input buffer can be overloaded on slower computers. The transmission speed must be reduced in this case. The 2400 bps. speed was successfully tested using 8Mhz IBM compatible laptop with 720 kB floppy, running ProComm. The 9600 bps speed can be used only when transferring to hard drive on fast microcomputers.

After the computer is connected to the recorder and properly configured communication software loaded, pressing any key on the computer keyboard (sending a byte) causes the 501 UV-B iometer to respond, displaying a menu of operations that can be performed under control of the computer (2).

2 is a list of functions from A to M. The function is invoked by pressing the corresponding key on the computer keyboard (either uppercase or lowercase). Most functions performed from the remote computer can also be done from the recorder's keypad (ref. ¶ 0). Access from the computer and the control panel can be simultaneous. Any change of setting is immediately indicated both on the computer screen and on the LCD. The UV-B iometer prompts for values to be entered if required. Every entry is checked when entered, and is rejected with an error message if illegal. When the entry is completed, the **ENTER** (or **RETURN**) key must be pressed.

The BACKSPACE key is not operative. If the entered value is incorrect, the entry can be aborted by pressing the **ESC** key until the main menu is displayed on the screen. Entering an illegal value does not alter any internal setting of the UV-B iometer.

Following is the detailed description of supported functions:

- A** Display current values and settings:  
Selecting this function causes the UV-B iometer to display the screen showing current settings and measured values (2). The contents of this screen are continuously updated, until any key is pressed. The speed of the update depends on the transmission speed.
- B** Recording ON/OFF:  
The UV-B iometer displays the current status of the recording (either ON or OFF) and prompts for confirmation to change it. Pressing 'Y' or 'y' key continues the operation, while 'N' or 'n' returns to the main menu without any changes (ref. ¶ 0).
- C** Printing ON/OFF:  
Turns ON or OFF the printout of measured data on the printer directly connected to the recorder (ref. ¶ 0).
- D** Set the printing & storing interval:  
Allows changing the recording and storing interval to one of the displayed values (1, 2, 3, 4, 5, 6, 10, 12, 15, 20, 30 or 60 min.). The current value is displayed, and the user is prompted to type the new one. Any value out of the displayed list is rejected. Interval change is disabled when the recording is ON (ref. ¶ 0).
- E** Clear data buffers:  
Clears the data storage buffer after the intention to do this is reconfirmed (ref. ¶ 0).



them on the disk. The user can select any portion of the recorded data by entering the date and time of the beginning and end of the required portion. The date and time of the first sample stored in memory is displayed on the screen when function **A** is used. The rules for date & time entering described for function **F** are valid here. After the beginning of the data to be transferred is typed in, the question is displayed on the screen:

**>> Transfer until now ? (Y/N)\_**

Pressing "Y" or "y" selects the portion of data starting at the previously entered time, and ending at the current time. If "N" or "n" is pressed, the prompt for the end date & time of the data for transfer is displayed. After the desired period is defined, the following prompt is shown:

**>> Open the log file - press any key ...  
then close the log file on beep, and press any key ...**

This message is a reminder to open the "log file" where the incoming data is captured, while simultaneously displayed on the screen. The end of data is signaled by short beeps (if the computer has a beeper) and the log file should be closed. Otherwise the subsequent dialogue with the UV-B iometer will also be captured. The action to open the log file depends on the communication software (for ProComm it is pressing the "Alt" and "F1" keys simultaneously). Note, that there must be enough space on the disk to be able to store all incoming data.

**Table IV** Example of data transferred to the computer.

---

```
"501 Meter S/N 12345"  
"Date","Time","SUV Det #1","SUV Det #1","Temp 1","Temp 2"  
"16.04.1991"," 4:30", 0.000, 0.000, 20, 20  
"16.04.1991"," 5:00", 0.000, 0.000, 20, 20  
"16.04.1991"," 5:30", 0.000, 0.000, 20, 20  
"16.04.1991"," 6:00", 0.007, 0.006, 20, 20  
"16.04.1991"," 6:30", 0.027, 0.025, 20, 20  
"16.04.1991"," 7:00", 0.068, 0.067, 20, 20  
"16.04.1991"," 7:30", 0.134, 0.131, 20, 20  
"16.04.1991"," 8:00", 0.231, 0.227, 20, 20,"WATCHMAN"  
"16.04.1991"," 8:30", 0.408, 0.405, 20, 20  
"16.04.1991"," 9:00", 0.591, 0.584, 20, 20  
"16.04.1991"," 9:30", 0.794, 0.785, 20, 20  
"16.04.1991","10:00", 1.011, 1.002, 20, 20  
"16.04.1991","10:30", 1.218, 1.208, 20, 20  
"16.04.1991","11:00", 1.381, 1.369, 20, 20  
"16.04.1991","11:30", 1.477, 1.461, 20, 20  
"16.04.1991","12:00", 1.401, 1.388, 20, 20
```

---

To simplify interpretation and further processing of the data it is decompressed by the UV-B iometer, and transmitted in text format, where labels are double-quoted, and values comma-separated (see 4 for an example). Data in this format can be imported by most commercial data processing programs (like spreadsheets). The cost of that simplification is the length of the transmitted block (57 bytes for one transmitted record), and consequently the transmission time.

The transfer of a full data buffer (5248 records) will take about 21 minutes and the size of the created file will be 299136 bytes. The word "WATCHMAN" at 8:00 means, that the "Watchman" function was used between 7:30 and 8:00 (ref.¶ 0).

**M** Change the detector name:

The user can change the name assigned to the detector. This name appears on the computer screen when using function **A**, in the printout header and in the header of the data transmitted to the computer.

If "garbage" is seen on the screen after an attempt to establish communication with the computer, the most likely reason is mismatch of the transmission speed between the computer and recorder. If text appearing on the screen is not readable due to overlapping or scrolling, the communication program is not configured to emulate the ANSI BBS terminal.



### 4.3 Modem

The 501 UV-B iometer was successfully tested for remote location operation. Any external modem, that has an auto-answer feature and matches one of the UV-B iometer transmission speeds (300, 600, 1200, 2400, 4800 or 9600 baud) can be used to inter-link the meter with the remote computer.

The modem should be connected to the **SERIAL 1** connector (6) using an appropriate cable. Since there are a variety of modem models on the market, the specific cable wiring is not shown. The UV-B iometer **SERIAL 1** output is configured as Data Terminal Equipment (DTE). Most modems are configured as Data Communication Equipment (DCE) and in that case the DTE-to-DCE straight-through cable with a male DB-9 on one end, and the appropriate connector for the modem should be ordered. Refer to the modem manual for detailed information.

Before the communication is established be sure that:

- The communication program is set up for: 8 data bits, 1 stop bit, no handshake, ANSI BBS terminal emulation, and no local echo (full duplex).
- The transmission speed of the UV-B iometer matches that set up for the communication software.
- Modems on both ends are configured to that speed if they don't support automatic speed selection.
- The modem connected to the meter is permanently configured to auto-answer, modem ignores DTR, the result codes are disabled, modem does not echo characters in local command state, and the telephone line goes on-hook as a result of carrier loss. For some modems supporting Hayes AT Commands, S Registers and having nonvolatile memory the following command will be adequate:

```
AT&D0Q1E0S0=2&C1&W0&Y0
```

Some modems must be configured using DIP switches. Refer to the Operation Manual of the modem for more information.

- The quality of the phone line is adequate for modem transmission.
- The "Call Waiting" feature of the phone line is disabled (currently only US and Canada customers).

After the phone number is dialed from the computer and connection between modems is established, the modems become transparent, and further operation is identical to that described in ¶ 0 for communication with the computer. Similarly, pressing any key causes the main menu to be displayed on the screen.

## 5 Maintenance

The 501 UV-B iometer is an automatic measurement system. As with any measurement equipment, some minimum maintenance is required to assure reliable data.

### 5.1 Watchman

The "Watchman" function was added to the 501 UV-B iometer to facilitate routine meter checking. When the meter is in the **DISPLAY MODE** (ref. ¶ 0) pressing the **EXIT** key causes the LCD to show condensed information about the UV-B iometer performance. The upper line contains information about the first detector, and the lower line above the second one. A sample display :

```
.....  
• D1 25.8M 23°C OK •  
• D2 0.0M 0°C NA •  
.....
```

D1 and D2 mean detector no.1 and no.2 respectively. The first value represents the daily total (of the current day) from the corresponding detector. The daily total is cleared at midnight. The second value shows the detector temperature. Both values are equal to zero if the detector is not connected or working. The mnemonic at the end can have two values:

**OK** - means that there is the signal from the detector

**NA** - there is no connection with the detector (disconnected or not working)

Note, that the information is correct even when there is no UV-B radiation, and the display should show **OK** during the night. Pressing any key causes the recorder to return back to the **DISPLAY MODE**.

Furthermore, the fact that the "Watchman" function was used, is marked in internal memory and will be indicated by the word "WATCHMAN" on both the printout and the data transferred to a computer. Marked is the first record that will be stored or printed after the "WATCHMAN" is used (ref.¶ 0 and ¶ 0).

### 5.2 Alarms and error messages

Two mechanisms are implemented to increase the reliability of the instrument and reduce the chance, that it records incorrect data.

The hardware "watchdog" is regularly initialized by the program operating the instrument. If for any reason (for ex. very strong electromagnetic impulse) the execution of the program is

disturbed, the system reset is performed. That is the only case in which the stored data can be lost, since the unpredictable activity of the processor could corrupt the memory contents. All settings are defaulted and the meter starts the recording (ref.¶ 0 for default settings). Additionally, an error message is generated.

In the background of all processes controlling the instrument, there are continuously running test routines that check the system performance. If the procedure finds a malfunction, an error message with its error code is displayed on the LCD and beeps are generated. Pressing any key cancels the error message, and the instrument returns to **DISPLAY MODE**. Since not all hardware can be tested in this way, failures can happen that are not detected.

If there are two simultaneous errors, their corresponding codes are added. Since the error codes are in binary sequence (1, 2, 4 ...), they create a unique error code for any combination of errors, and the particular error reasons can be resolved (for example: ERROR 5 means that the watchdog reset occurred and the nonvolatile memory battery is discharged). The following error codes are defined:

- 1 Watchdog reset occurred. All stored data are lost and settings are defaulted. The place, where the recorder is installed should be checked to eliminate the potential source of strong electromagnetic interferences, that is produced for example by the arcing. Arc lamps are extremely strong sources of electromagnetic noise when they are ignited.
- 2 Memory error. There is an internal memory defect that can cause the data corruption. The UV-B iometer should be returned to the manufacturer for repair.
- 4 The nonvolatile memory battery is discharged, and should be replaced by the manufacturer. The guaranteed life of the battery is 10 years minimum.
- 8 The signal from one of the two detectors has been discontinued. The detector was disconnected or does not work properly.
- 16 The offset of either detector was automatically changed by more than .01 [MED/HR] between successive midnights (see the recorded data to find the amount the offset changed). The reason could be the moisture inside the detector, a drastic change of the ambient temperature between midnights (more than 30°C), or malfunction of the circuitry inside the detector.

### **5.3 Cleaning and changing the internal batteries.**

The UV-B iometer detector can be cleaned using water with any mild detergent. The quartz dome of the detector should be cleaned regularly, since its transparency for UV can be reduced by any residue on its surface. The recorder is designed for indoor operation and the cleaning should be done using a soft cloth.

There are two internal NiCd rechargeable D-size cells mounted on the recorder board. They

provide power for the system to operate in case of external power failure. The cells should be replaced every time they seem to lose their capacity. To change the batteries it is necessary to remove 4 screws at the bottom of the recorder case, and then lift the top cover. The batteries are mounted in holders. Battery polarity, which is marked on the battery holder, must be observed.

Note, that there is a small battery on the microcontroller board to maintain memory contents and time. This battery has a guaranteed lifetime of at least 10 years and can be replaced only by the manufacturer. There is an error generated before that battery is discharged below its critical level.

## **5.4 Troubleshooting**

In this chapter, some problems that a user can face when using the 501 UV-B iometer are described. If there are any malfunction symptoms, good practice is to check that:

- all cables are correctly plugged in,
- the power is properly supplied,
- the detector is installed according to the rules in ¶ 0.

Some specific situations are described below in convention: symptom, possible cause and correction.

- The recorder works but there is no signal from the detector:
  - broken cable: use ohmmeter to check the continuity of all wires in the cable. The cable connection diagram is shown in Appendix.
  - no power supplied to the detector: check the presence of 5V between pin 5 (GND) and 9 (+5V) of the **DETECTOR 1** connector at the back panel of the recorder. If there is no 5V there, the fuse F3 (circuit diagram in the Appendix) should be replaced by one of the same nominal current (100 mA). If the new fuse is instantly burned, the detector cable should be checked for shorts between wires. If there is no cable short, the detector should be returned for repair.
  - burned input protection of the recorder: the detector cable should be switched from the **DETECTOR 1** input to the **DETECTOR 2** input. If after the change the detector works properly, one of the RP2 resistors (8 pack resistor) is probably defective. It can happen, that there is a signal only from only the UV-B or the temperature.
- The zero level of the detector is not stable:
  - moisture inside the detector: the desiccant in the detector should be replaced.
- An ERROR 1 message often appears or the processor loses control over the UV-B iometer:
  - the recorder is located near a source of strong electromagnetic interferences (arc lamps and their power supplies).

- The temperature controller does not work:
  - there is no power supplied from the AC line (the UV-B iometer needs power from AC line to provide temperature stabilization).
  - fuse F1 located on the temperature controller board is open (in this case the EXT. POWER indicator does not light - see: 501 temperature controller schematic in the Appendix).
  - broken wire in the detector cable.
  - defective Peltier junction.
  
- The temperature controller is not able to maintain the temperature for ambient temperature between -30°C and +40°C:
  - the ambient temperature is too high or too low in comparison to thermostating temperature.
  
- The printer connected to the recorder does not print:
  - the printout is not enabled on the UV-B iometer (ref. ¶ 0).
  - the printer is not turned ON LINE.
  - end of paper encountered.
  - the printer cable is incorrect (ref. 8).
  
- There is no communication between the computer and UV-B iometer:
  - the cable is not correctly wired (ref. 8).
  - the cable is not plugged into the **SERIAL 1** connector.
  - the communication software is configured for the **COM** port other than the UV-B iometer is connected to.
  
- The communication does not work properly ("garbage" or non readable information on the screen):
  - the setup of the communication software is incorrect (ref. ¶ 0).

## 6 Data interpretation and calibration.

The biological effectiveness of the UV irradiation is measured in MED/HR (Minimum Erythema Dose per Hour). One MED/HR would cause minimal redness of the average skin after a one hour irradiation . The integral of the cross-multiplication of irradiating flux ( $\text{W cm}^{-2}\text{nm}^{-1}$ ) and the Erythema Action Spectrum (McKinlay and Diffey 1987, see Appendix C) gives the Effective Power. It was established that:

$$1 \text{ [MED/HR]} = 5.83 \cdot 10^{-6} \text{ [W cm}^{-2}\text{]} \text{ of Effective Power}$$

for an MED of 21 mJ per  $\text{cm}^2$  effective dose.

The Biologically Effective Dose is measured by integrating the Biologically Effective Power over a specified period of time. For example, irradiating the skin by a source having 2 [MED/HR] output for 30 minutes will result in 1 MED.

The Erythema Action Spectrum is only one of many action spectra observed in nature, with similar slope and wavelength range. Thus, the UV-B iometer can indicate the effectiveness of solar radiation for the induction of sunburn, phytoplankton mortality, skin elastosis and thymine dimers among other effects. Also, the UV-B iometer can be used for global UV monitoring, especially in conjunction with information about ozone thickness, cloud cover and air pollution.

The 501 UV-B iometer is initially calibrated by the manufacturer, to show the biological effectiveness of the solar radiation, according to the McKinlay-Diffey Erythema Action Spectrum and a 21  $\text{mJ/cm}^2$  to induce minimal skin redness. The detector is calibrated for a clear sky, 30° solar zenith angle, 2.7 mm ozone column thickness, at sea level and at a 25°C temperature of the phosphor.

10 shows the differences between the measured and calculated values for different ozone thicknesses and solar zenith angles. A computer model is used to calculate the UV radiation reaching the Earth level (Green, 1979). The results can vary with measurement conditions, but it shows the order of magnitude of errors that can be expected. More important is to maintain the repeatability between units, and the spectral response of the detector is strictly controlled over the entire technological process. 1 shows also the allowed variation of the detectors responses. For the two extreme responses, the differences between readings should be within 6 % for ozone thickness from 2.7 to 3.3 mm, and solar zenith angles 0 to 70 degree.

The UV-B iometer should be periodically re-calibrated. The recommended period is one year. A reference detector can be ordered for that purpose. It can be connected to the second input of the UV-B iometer and used for comparative recording for a couple of days. The temperature stabilization should be turned ON, and set to 25°C, during the comparison. Then, the data from both detectors can be loaded into the computer and compared using general purpose data processing software. The regression method is a very convenient way to find the scale coefficient that should be entered into the recorder in order to obtain readings as close to the reference, as

possible.

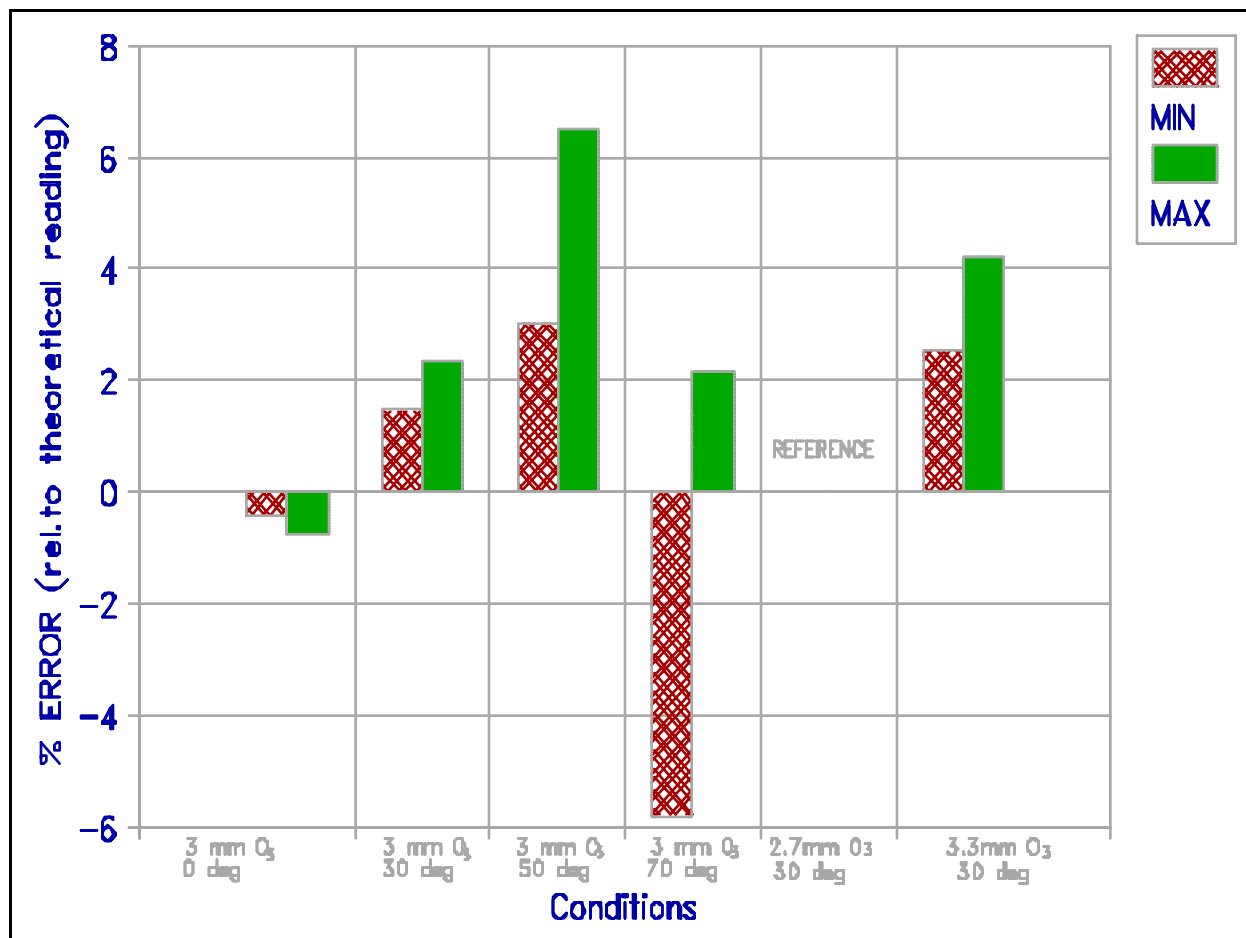

**Figure 10** The measurement error due to spectral response variation.

## 7 Principles of operation

The principle of UV radiation measurement used in the 501 UV-B iometer is the same as that used for the Robertson-Berger meter. The solar light goes through the input filters, including a teflon layer that improves the cosine response of the detector. Then the partially filtered light, containing the whole UV spectrum, excites the phosphor. The visible light emitted by the phosphor is detected by the GaAs diode. The diode and the phosphor are encapsulated in the metal enclosure which is thermostated by the Peltier element. The current produced by the GaAs diode is amplified and converted to frequency inside the detector. The temperature of the detector is converted to frequency also. The military and industrial grade components selected assure stable operation over a wide conditions.

The frequency signal from the detector is transmitted to the recorder. The temperature and UV-B values are decoded and taken for further processing. The recorder is based on DS2250 (Dallas Semiconductor) microcontroller system equipped with interfacing and buffering circuitry. The operation is controlled by the program loaded into the DS2250. The reconfiguration of instrument functions needs only new software which is loaded via the serial port (after reprogramming is enabled by switching a jumper).



## **Appendix A Interfaces**

### **PARALLEL PRINTER INTERFACE**

Pin	Signal	Transmitter	Description
1	STROBE/	UV-B iometer	Strobe pulse for data entry.
2	DATA1	"	Data bit (LSB)
3	DATA2	"	Data bit
4	DATA3	"	Data bit
5	DATA4	"	Data bit
6	DATA5	"	Data bit
7	DATA6	"	Data bit
8	DATA7	"	Data bit
9	DATA8	"	Data bit
11	BUSY	PRINTER	"HIGH" indicates that the printer is not ready
7-25	GND		Ground

### **SERIAL INTERFACE**

Pin	Signal	Transmitter	Description
1	DCD	Computer	Data Carrier Detected
2	RxD	Computer	Received Data
3	TxD	UV-B iometer	Transmitted Data
4	DTR	UV-B iometer	Data Terminal Ready
5	GND		Ground

### **DETECTOR INTERFACE**

Pin	Signal	Transmitter	Description
1	H1A	Recorder	Supply for Peltier element - lead A
2	H1B	Recorder	Supply for Peltier element - lead B
4	PGND		Protective ground (EARTH)
5	GND		Power ground
6	FT	Detector	Temperature signal (frequency, +/- 5V)
8	FUV	Detector	UV signal (frequency, +/- 5V)
9	+5V	Recorder	Power for the detector (fused 100 mA)

## **Appendix B Circuit diagrams and partlists**

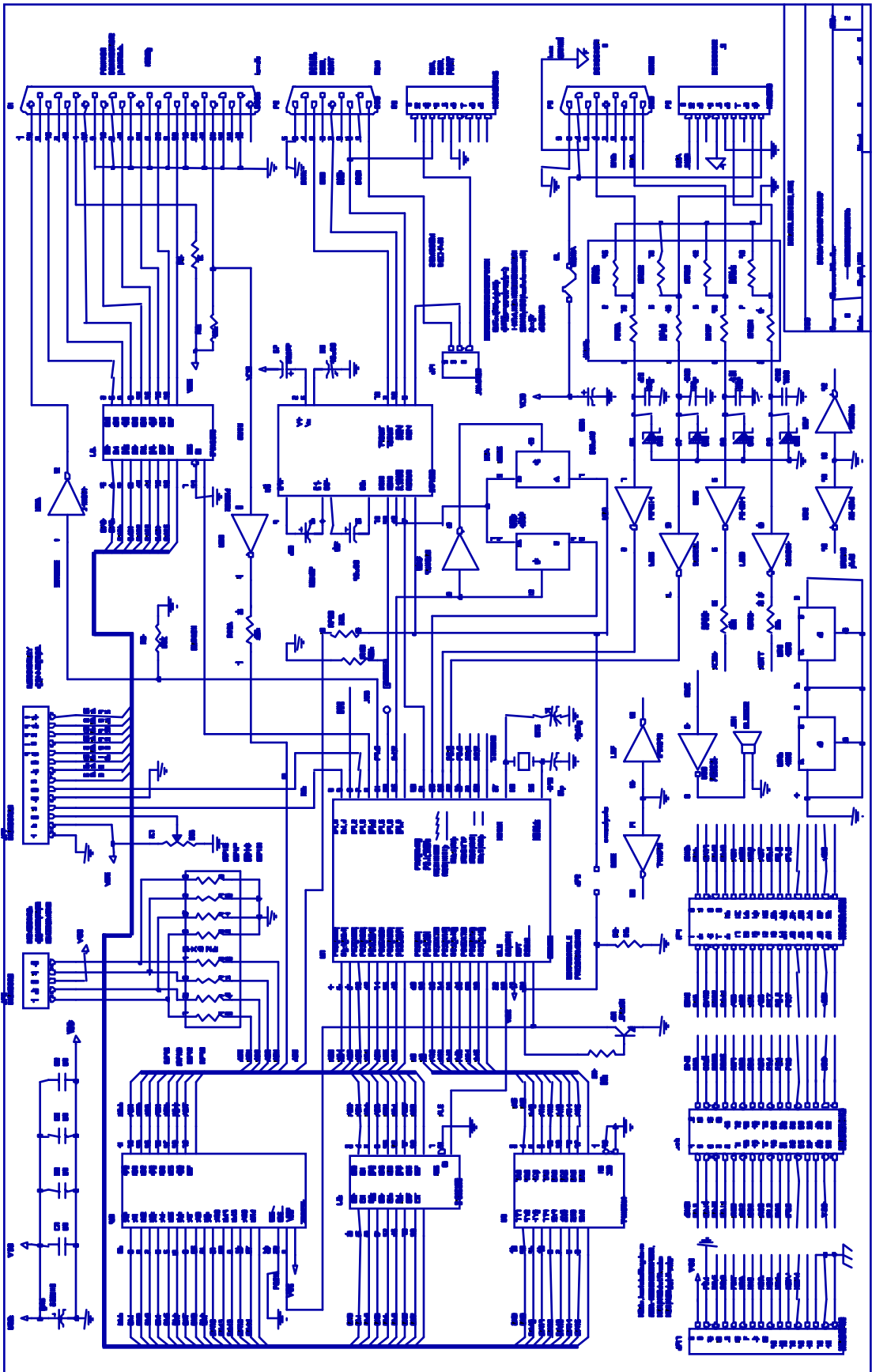

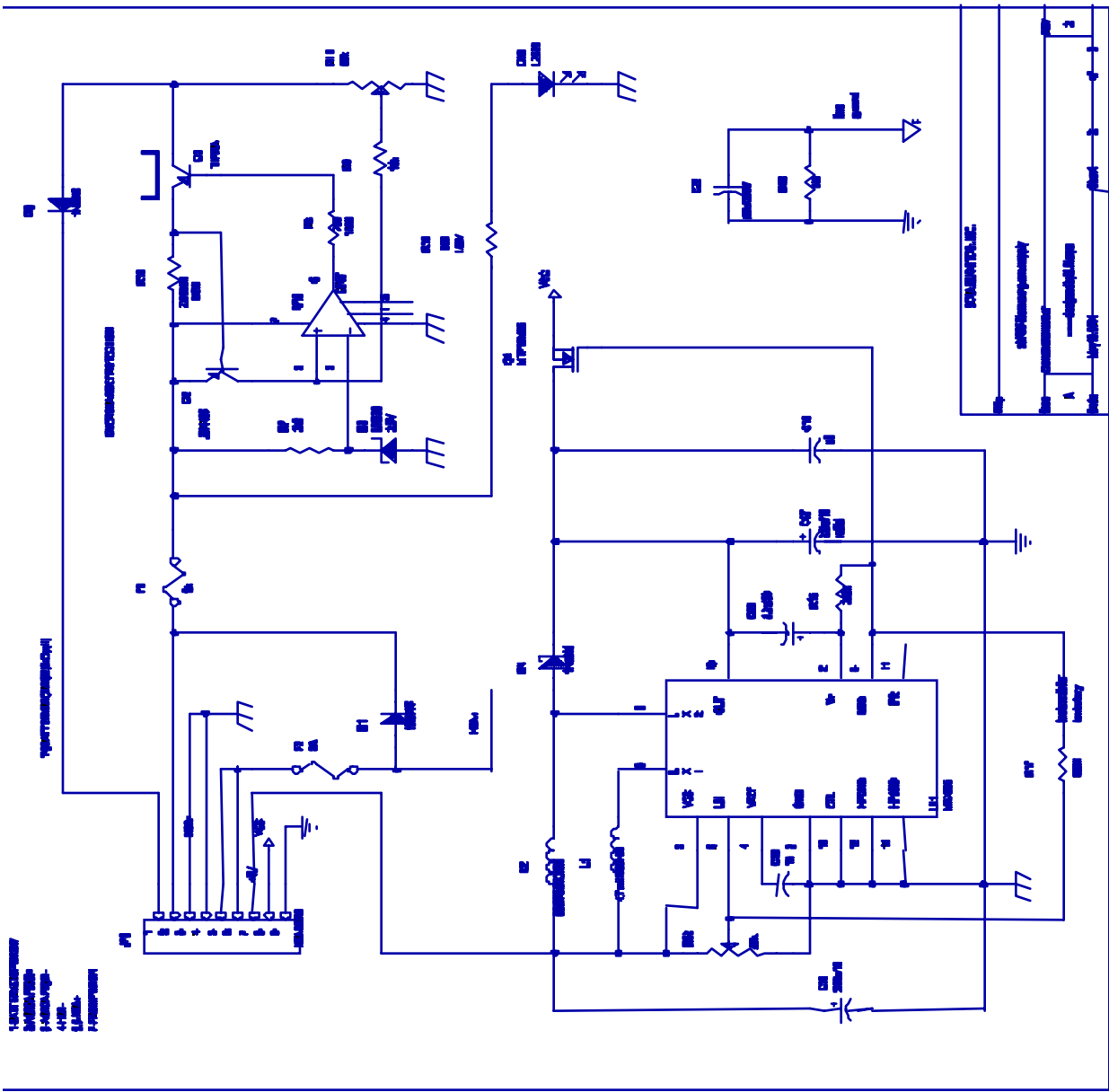

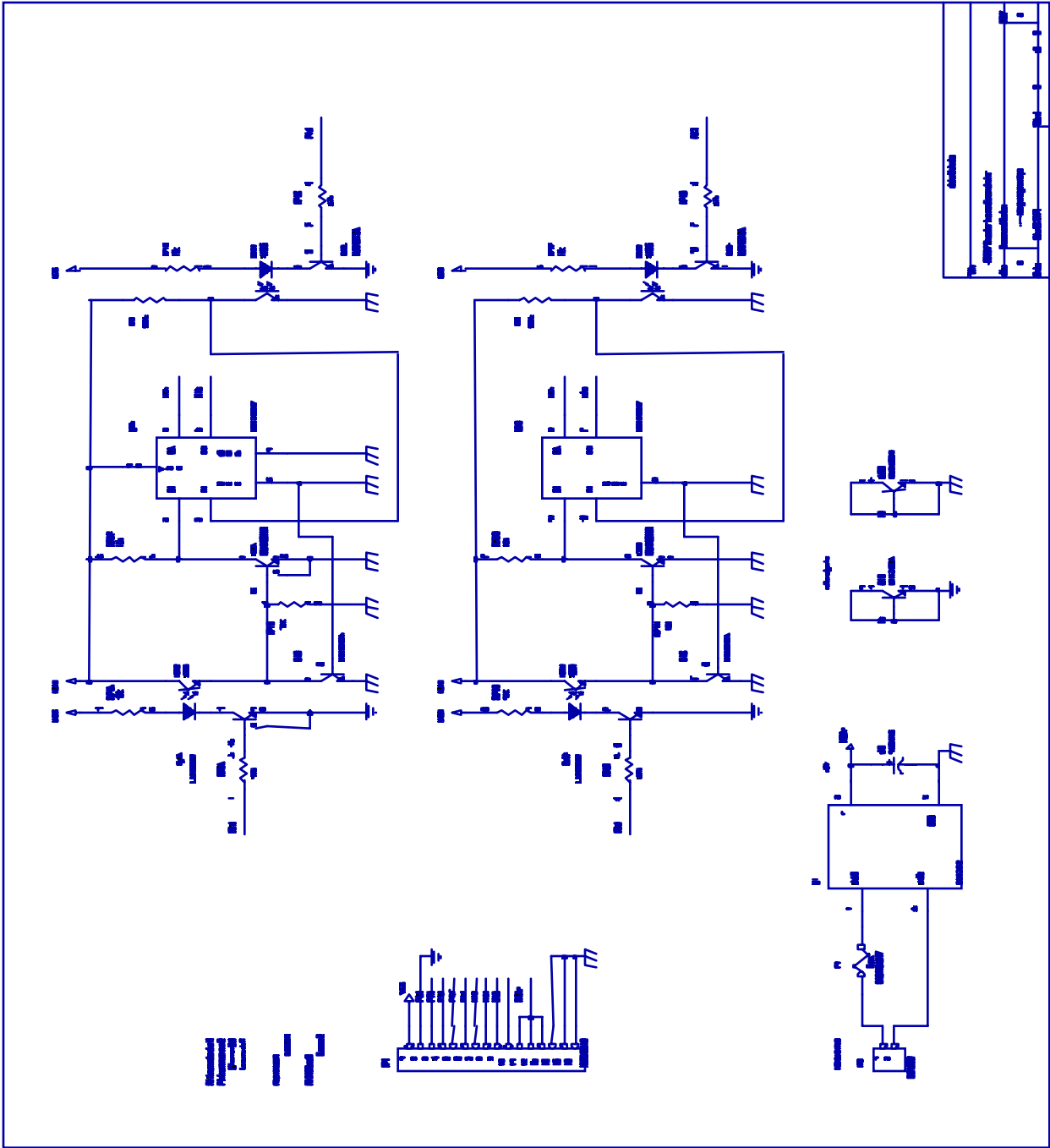

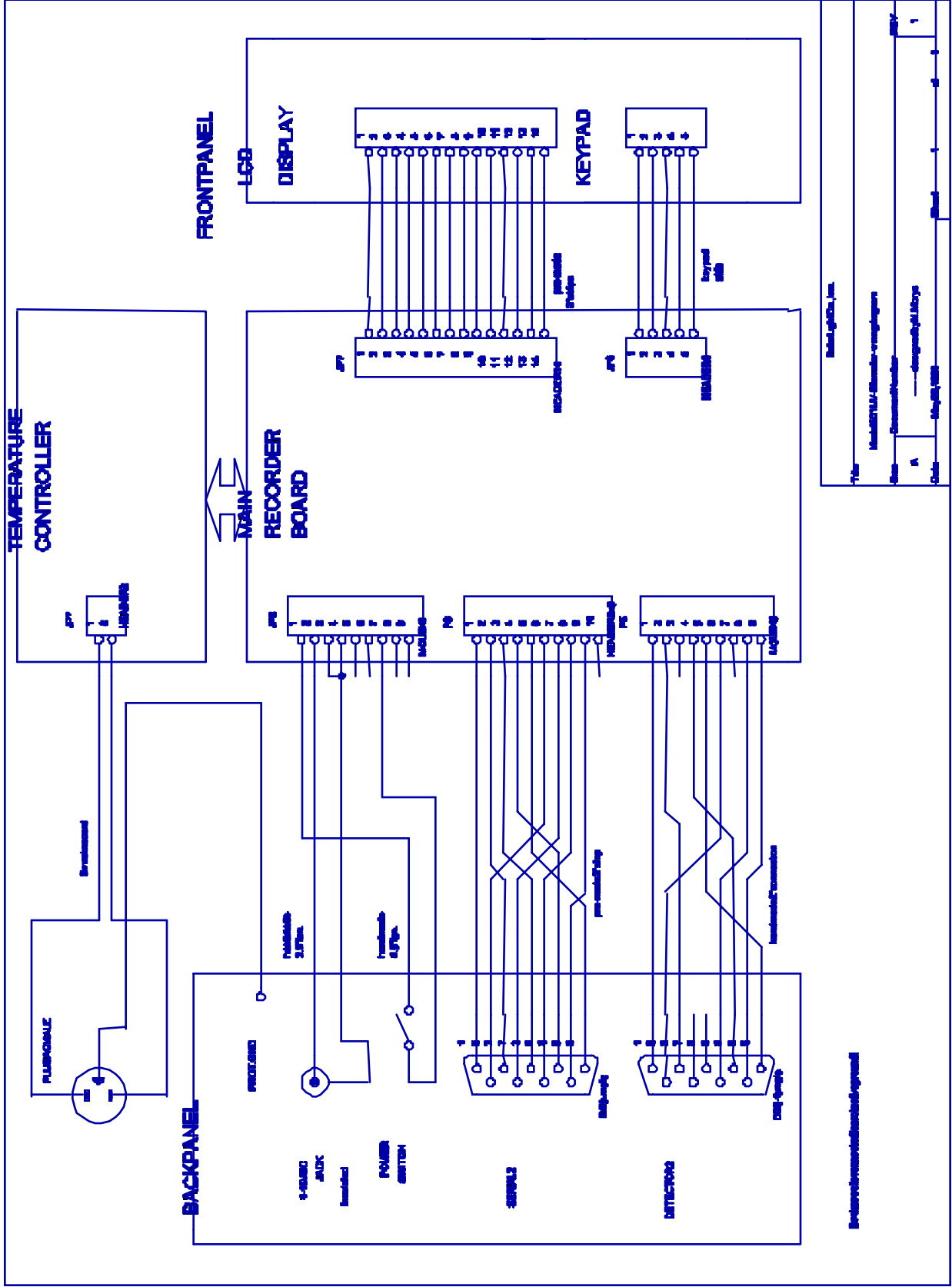

Title: **Temperature Controller**  
 Rev: **1**  
 Date: **10/10/2000**  
 Author: **...**  
 Checked: **...**  
 Approved: **...**

**Appendix C Erythema action spectrum**

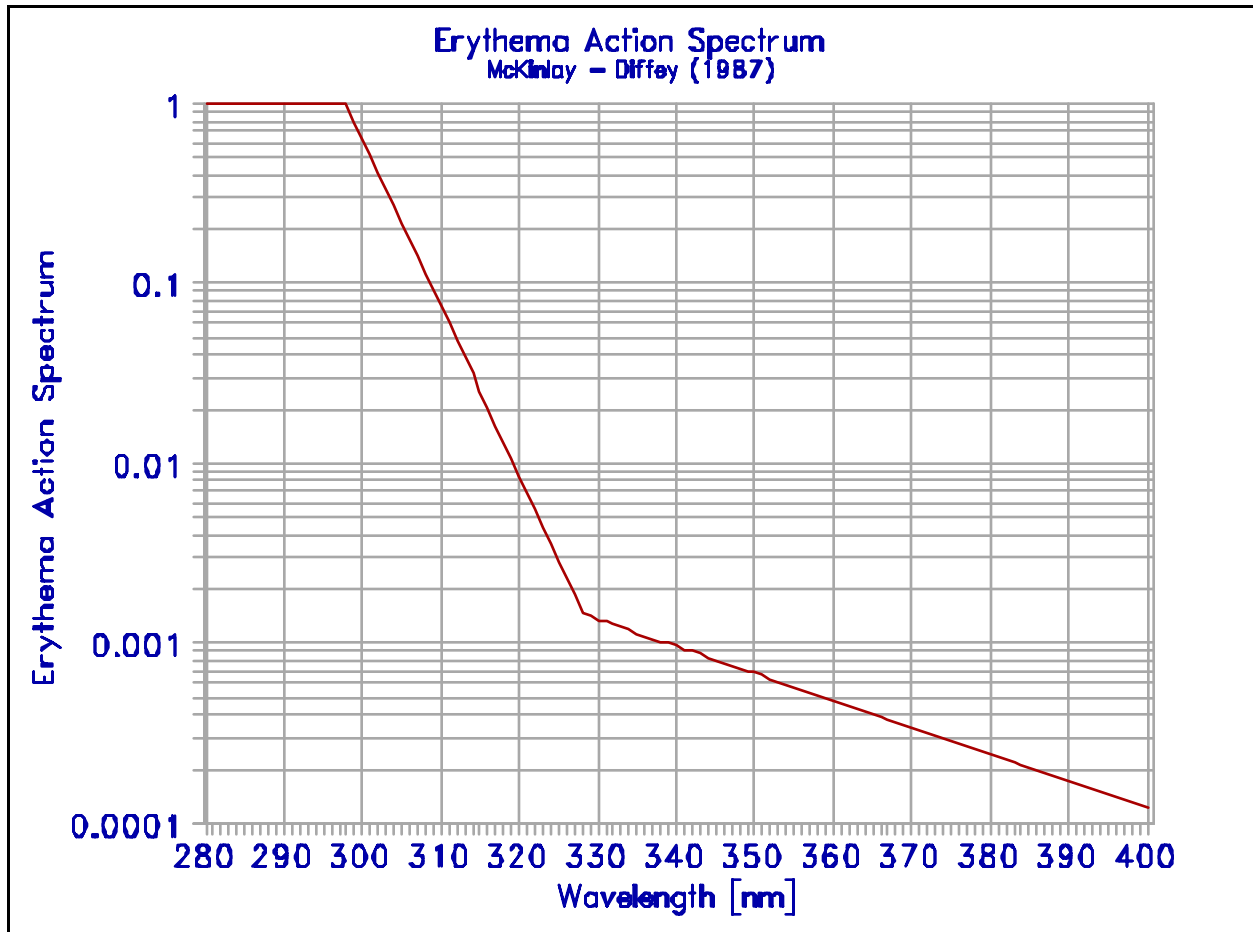

**Figure 15** Erythema action spectrum (McKinlay and Diffey 1987).

## **Literature**

- Berger, D., (1976) The sunburning ultraviolet meter: design and performance. In *Photochem. Photobiol.* **24**, 587-593.
- Blumthaler, M., W. Ambach (1986) Messungen der Temperaturkoeffizienten des Robertson-Berger Sunburn Meters und des Eppley UV-radiometers. In *Arch. Met. Geophys. Biocl., Ser. B*, **36**, 357-363.
- Blumthaler, M., W. Ambach, M. Morys, J. Slomka (1989) Comparison of Robertson-Berger UV Meters From Innsbruck and Belsk. In *Publs. Inst. Geophys. Pol. Acad. Sc.*, **D-32** (230), Warsaw.
- McKinlay, A. and B.L. Diffey (1987) A reference action spectrum for ultra-violet induced erythema in human skin. In *Human Exposure to Ultraviolet Radiation: Risks and Regulations* (Edited by W.F. Passchier and B.F.M. Bosnjakovic), pp83-87. Elsevier, Amsterdam.